



BIMOBJECTS



TENSILE STRUCTURE
Renders
WWW.INDEMANDTRADING.CO.ZA/RENDERS

In Demand Trading Drawing Office

Design | Engineering | Structural Analysis | Membranes
Stretch Fabric | Shadecloth | Architectural PVCs

In Demand Trading (Pty) Ltd: move beyond 3D to Digital Prototyping

With Autodesk Inventor software, we can easily integrate AutoCAD® and 3D data into a single digital model to create a virtual representation of the final product.

Inventor software helps us to realize the benefits of Digital Prototyping by providing an associativeread connection to native DWG files so there's no risk of inaccurate translations. Utilizing valuable DWG data with Inventor can help compete more effectively, service your clients better, and do more in-house.

Structural Analysis Videos

In Demand Trading (Pty) Ltd offers the following videos showing wind action on tensile structures.

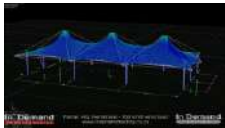

Ferrari 402 120 km/h

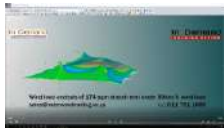

Thermoflex 80 km/h

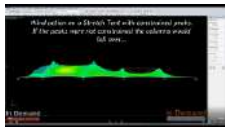

Thermoflex 120 km/h

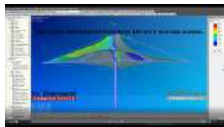

Ferrari 402 144 km/h

if online click on the image to view the video

Improve design collaboration and communication

Reduce errors and associated engineering change orders before manufacturing by generating manufacturing documentation directly from our validated 3D digital prototype.

Our software offers rapid and accurate output of production-ready drawings directly from the 3D model. Inventor product bundles also include Autodesk® AutoCAD® Mechanical software for situations that require a high-productivity 2D mechanical drafting tool.

Our models are integrated with Autodesk® Vault, enabling the quick and secure exchange of design data and promoting earlier collaboration between design and manufacturing workgroups.

Different workgroups can manage and track all components of a digital prototype with free* Autodesk® Design Review software—the all-digital way to review, measure, mark up, and track changes to designs enabling better reuse of crucial design data, management of bills of materials (BOMs), and collaboration with other teams and partners.

Our models enable you to show case your intended design to your client in realistic photo real renders. Costing can be done accurately as the BOM are provided at conceptual stage well prior to quotation.

Deliver innovative products faster

In Demand Trading (Pty) Ltd services provide professional engineering solutions for 3D design, structural analysis, product rendering and communication that help you take advantage of a Digital Models to make great products cost-effectively and in less time.

In Demand Trading (Pty) Ltd makes use of Autodesk Inventor software for Digital Prototyping. The Inventor model is an accurate 3D digital prototype that enables you to validate the form, fit, and function of a design as you work, minimizing the need to test the design with physical prototypes.

By enabling you to design, visualize, and simulate your products digitally, Inventor software helps you connect more effectively, reduce errors, and deliver great product designs faster. Make use of our extensive library of designs developed over the past 27 years in the tensile membrane industry or work with our professional team and let them turn your design dreams into reality.

Services

In Demand Trading (Pty) Ltd offers the following services to our clients:
Standard designs, custom designs, 3D model formulation, renderings, manufacturing drawings, stress analysis, wind loading analysis, BOMs, hardware specification, rigging detailing, general assembly drawings, membrane patterns, foundation layouts.

Design and validate products digitally

With an intuitive design environment for developing initial concept sketches and models of parts and assemblies. Inventor software provides powerful parametric modeling, robust direct editing tools and advanced surfacing modeling capabilities with T-splines. We can automate the advanced geometry creation of intelligent components, such as membranes, steel frames, sail plates, tube and pipe runs, rigging and hardware . Inventor software also helps reduce the geometry burden so we can rapidly build and refine digital prototypes that validate design functions and help minimize manufacturing costs.

Traditionally, validating the operating characteristics of a design before it was built meant hiring expensive specialists. But with In Demand Trading (Pty) Ltd, you don't need to be a simulation expert to effectively simulate and optimize designs digitally.

By simulating stress with our structural analysis, and our stress analysis models we can predict deflection, and motion, you can optimize and validate your design under real-world conditions, before the product or part is ever built.



PERSPECTIVE VIEW

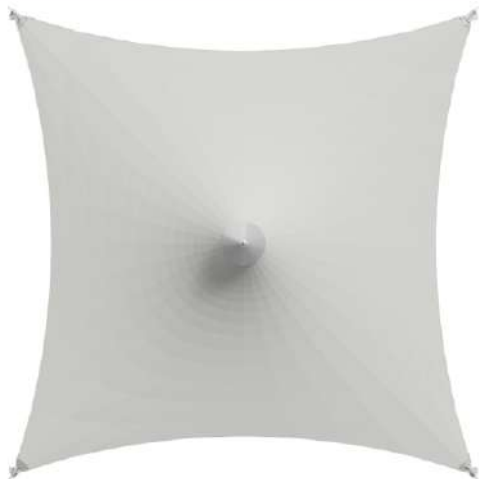

TOP VIEW



FRONT VIEW



SIDE VIEW

IN DEMAND TRADING (PTY) LTD
 STEPPING STONES GARDEN VILLAGE
 283 OLD HONEYDEW ROAD WEST
 NORTHRIDING, JHB, GAUTENG, RSA



INDEMANDdrawingoffice.co.za
 Download BIM, DWG and 3D model tensile shade structures

DESCRIPTION

STAINLESS STEEL HIGH TENSILE WIND RATED UMBRELLA

CATEGORY

BIMOBJECTS

CATEGORY

STANDARD STRUCTURE

MEMBRANE OPTIONS

ARCHITECTURAL PVC

IMAGE FORMAT

.PNG

SOFTWARE

AUTODESK INVENTOR

YEAR DRAWN

2001

YEAR FIRST MANUFACTURED

2001

MODEL FORMAT

.BIM / .SAT

SCALE

NOT TO SCALE

COPY RIGHT YEAR

2001

SIZES

VARIOUS

INDEMANDDRAWINGOFFICE.CO.ZA LINK



DRAWING CATEGORY

RENDER STD-SS001

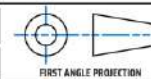

FIRST ANGLE PROJECTION



THE CONTENTS OF THIS DRAWING IS THE SOLE PROPERTY OF IN DEMAND TRADING (PTY) LTD
 AND MAY NOT BE COPIED OR DIVULGED TO ANY THIRD PARTY WITHOUT THE WRITTEN CONSENT
 In Demand Trading (Pty) Ltd | Reg Number: 2014/057552/07 | VAT Number: 4568746

T: // +27 (0)21 791 1888
 SALES@INDEMANDTRADING.CO.ZA
 WWW.INDEMANDTRADING.CO.ZA



PERSPECTIVE VIEW



TOP VIEW



FRONT VIEW



SIDE VIEW

IN DEMAND TRADING (PTY) LTD
 STEPPING STONES GARDEN VILLAGE
 283 OLD HONEYDEW ROAD WEST
 NORTHRIDING, JHB, GAUTENG, RSA



INDEMANDdrawingoffice.co.za
 Download BIM, DWG and 3D model tensile shade structures

DESCRIPTION MILD STEEL RETRACTABLE HIGH TENSILE WIND RATED UMBRELLA			
CATEGORY STANDARD STRUCTURE			
CATEGORY STANDARD STRUCTURE	IMAGE FORMAT .PNG	SOFTWARE AUTODESK INVENTOR	YEAR DRAWN 2001
MEMBRANE OPTIONS ARCHITECTURAL PVC		MODEL FORMAT .BIM / .SATT	YEAR FIRST MANUFACTURED 2001

INDEMANDDRAWINGOFFICE.CO.ZA LINK



DRAWING CATEGORY
RENDER STD-MS001



FIRST ANGLE PROJECTION

SCALE NOT TO SCALE	COPY RIGHT YEAR 2001
SIZES VARIOUS	



THE CONTENTS OF THIS DRAWING IS THE SOLE PROPERTY OF IN DEMAND TRADING (PTY) LTD AND MAY NOT BE COPIED OR DIVULGED TO ANY THIRD PARTY WITHOUT THE WRITTEN CONSENT
 In Demand Trading (Pty) Ltd | Reg Number: 2014/057552/07 | VAT Number: 4568746

T: // +27 (0)21 791 1888
 SALES@INDEMANDTRADING.CO.ZA
 WWW.INDEMANDTRADING.CO.ZA



PERSPECTIVE VIEW

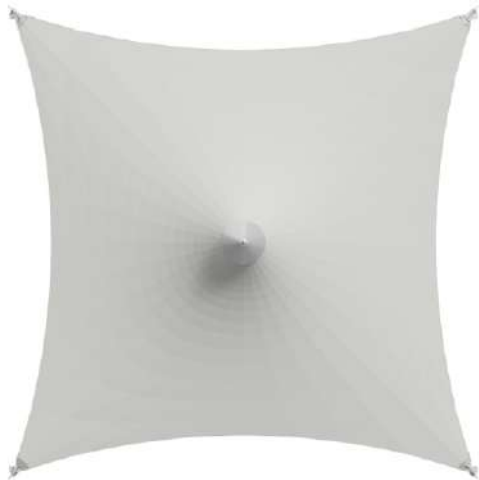

TOP VIEW



FRONT VIEW



SIDE VIEW

IN DEMAND TRADING (PTY) LTD
 STEPPING STONES GARDEN VILLAGE
 283 OLD HONEYDEW ROAD WEST
 NORTHRIDING, JHB, GAUTENG, RSA

T: // +27 (0)21 791 1888
 SALES@INDEMANDTRADING.CO.ZA
 WWW.INDEMANDTRADING.CO.ZA



INDEMANDdrawingoffice.co.za
 Download BIM, DWG and 3D model tensile shade structures

DESCRIPTION

FIXED FRAME HIGH TENSILE WIND RATED UMBRELLAS

CATEGORY
 STANDARD STRUCTURE

CATEGORY
 STANDARD STRUCTURE

MEMBRANE OPTIONS
 ARCHITECTURAL PVC

IMAGE FORMAT
 .PNG

SOFTWARE
 AUTODESK INVENTOR

YEAR DRAWN
 2002

MODEL FORMAT
 .BIM / .SAT

YEAR FIRST MANUFACTURED
 2002

SCALE
 NOT TO SCALE



FIRST ANGLE PROJECTION

COPY RIGHT YEAR
 2002

SIZES
 VARIOUS

INDEMANDDRAWINGOFFICE.CO.ZA LINK

CLICK HERE

DRAWING CATEGORY
 RENDER STD-FF001



THE CONTENTS OF THIS DRAWING IS THE SOLE PROPERTY OF IN DEMAND TRADING (PTY) LTD
 AND MAY NOT BE COPIED OR DIVULGED TO ANY THIRD PARTY WITHOUT THE WRITTEN CONSENT
 In Demand Trading (Pty) Ltd | Reg Number: 2014/057552/07 | VAT Number: 4568746



PERSPECTIVE VIEW



TOP VIEW



FRONT VIEW



SIDE VIEW

IN DEMAND TRADING (PTY) LTD
 STEPPING STONES GARDEN VILLAGE
 283 OLD HONEYDEW ROAD WEST
 NORTHRIDING, JHB, GAUTENG, RSA



INDEMANDdrawingoffice.co.za
 Download BIM, DWG and 3D model tensile shade structures

DESCRIPTION

FIXED FRAME HIGH TENSILE WIND RATED UMBRELLAS FS

CATEGORY
 STANDARD STRUCTURE

CATEGORY
 STANDARD STRUCTURE

MEMBRANE OPTIONS
 ARCHITECTURAL PVC

IMAGE FORMAT
 .PNG

SOFTWARE
 AUTODESK INVENTOR

YEAR DRAWN
 2011

MODEL FORMAT
 .BIM / .SAT

YEAR FIRST MANUFACTURED
 2011

SCALE
 NOT TO SCALE



FIRST ANGLE PROJECTION

COPY RIGHT YEAR
 2019

SIZES
 VARIOUS

INDEMANDDRAWINGOFFICE.CO.ZA LINK



DRAWING CATEGORY
 RENDER STD-FF002



THE CONTENTS OF THIS DRAWING IS THE SOLE PROPERTY OF IN DEMAND TRADING (PTY) LTD
 AND MAY NOT BE COPIED OR DIVULGED TO ANY THIRD PARTY WITHOUT THE WRITTEN CONSENT
 In Demand Trading (Pty) Ltd | Reg Number: 2014/057552/07 | VAT Number: 4568746

T: // +27 (0)21 791 1888
 SALES@INDEMANDTRADING.CO.ZA
 WWW.INDEMANDTRADING.CO.ZA



PERSPECTIVE VIEW



TOP VIEW



FRONT VIEW



SIDE VIEW

IN DEMAND TRADING (PTY) LTD
 STEPPING STONES GARDEN VILLAGE
 283 OLD HONEYDEW ROAD WEST
 NORTHRIDING, JHB, GAUTENG, RSA



INDEMANDdrawingoffice.co.za
 Download BIM, DWG and 3D model tensile shade structures

DESCRIPTION

OCTAGONAL FIXED FRAME HIGH TENSILE WIND RATED UMBRELLA

CATEGORY
 STANDARD STRUCTURE

CATEGORY
 STANDARD STRUCTURE

MEMBRANE OPTIONS
 ARCHITECTURAL PVC

IMAGE FORMAT
 .PNG

SOFTWARE
 AUTODESK INVENTOR

YEAR DRAWN
 2012

MODEL FORMAT
 .BIM / .SATT

YEAR FIRST MANUFACTURED
 2012

SCALE
 NOT TO SCALE

COPY RIGHT YEAR
 2019

SIZES
 VARIOUS

INDEMANDDRAWINGOFFICE.CO.ZA LINK



DRAWING CATEGORY
 RENDER STD-OC001



FIRST ANGLE PROJECTION



THE CONTENTS OF THIS DRAWING IS THE SOLE PROPERTY OF IN DEMAND TRADING (PTY) LTD
 AND MAY NOT BE COPIED OR DIVULGED TO ANY THIRD PARTY WITHOUT THE WRITTEN CONSENT
 In Demand Trading (Pty) Ltd | Reg Number: 2014/057552/07 | VAT Number: 4568746

T// +27 (0)21 791 1888
 SALES@INDEMANDTRADING.CO.ZA
 WWW.INDEMANDTRADING.CO.ZA



PERSPECTIVE VIEW

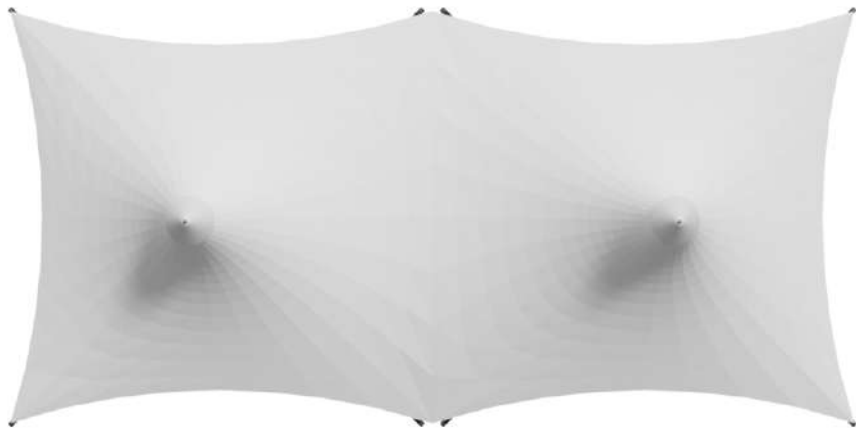

TOP VIEW



FRONT VIEW

IN DEMAND TRADING (PTY) LTD
 STEPPING STONES GARDEN VILLAGE
 283 OLD HONEYDEW ROAD WEST
 NORTHRIDING, JHB, GAUTENG, RSA



INDEMANDdrawingoffice.co.za
 Download BIM, DWG and 3D model tensile shade structures

DESCRIPTION

MONO FIXED FRAME HIGH TENSILE WIND RATED UMBRELLA

CATEGORY
 STANDARD STRUCTURE

CATEGORY
 STANDARD STRUCTURE

MEMBRANE OPTIONS
 ARCHITECTURAL PVC

IMAGE FORMAT
 .PNG

SOFTWARE
 AUTODESK INVENTOR

YEAR DRAWN
 2012

MODEL FORMAT
 .BIM / .SAT

YEAR FIRST MANUFACTURED
 2012

SCALE
 NOT TO SCALE

COPY RIGHT YEAR
 2019

SIZES
 6.0 X 3.0M

INDEMANDDRAWINGOFFICE.CO.ZA LINK



DRAWING CATEGORY
 RENDER STD-FF006

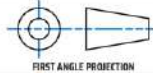

FIRST ANGLE PROJECTION



THE CONTENTS OF THIS DRAWING IS THE SOLE PROPERTY OF IN DEMAND TRADING (PTY) LTD
 AND MAY NOT BE COPIED, DIVULGED TO ANY THIRD PARTY WITHOUT THE WRITTEN CONSENT
 In Demand Trading (Pty) Ltd | Reg Number: 2014/057552/07 | VAT Number: 4568746

T// +27 (0)21 791 1888
 SALES@INDEMANDTRADING.CO.ZA
 WWW.INDEMANDTRADING.CO.ZA



PERSPECTIVE VIEW

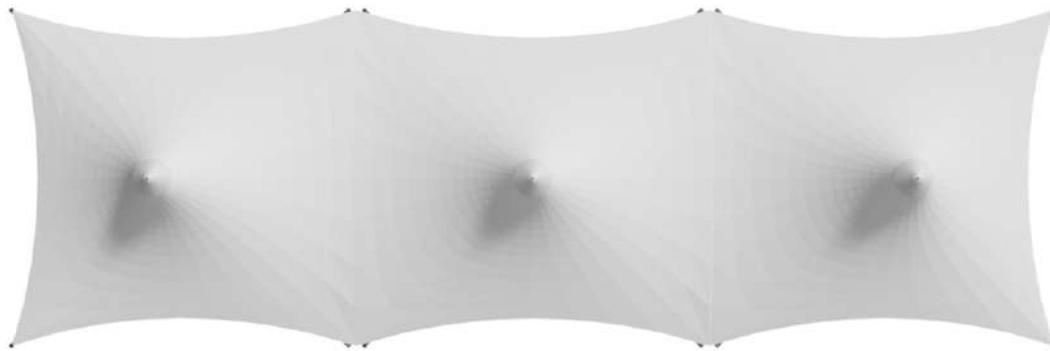

TOP VIEW



FRONT VIEW

IN DEMAND TRADING (PTY) LTD
 STEPPING STONES GARDEN VILLAGE
 283 OLD HONEYDEW ROAD WEST
 NORTHRIDING, JHB, GAUTENG, RSA



INDEMANDdrawingoffice.co.za
 Download BIM, DWG and 3D model tensile shade structures

T// +27 (0)21 791 1888
 SALES@INDEMANDTRADING.CO.ZA
 WWW.INDEMANDTRADING.CO.ZA

DESCRIPTION

MONO FIXED FRAME HIGH TENSILE WIND RATED UMBRELLA

CATEGORY
 STANDARD STRUCTURE

CATEGORY
 STANDARD STRUCTURE

MEMBRANE OPTIONS
 ARCHITECTURAL PVC

IMAGE FORMAT
 .PNG

SOFTWARE
 AUTODESK INVENTOR

YEAR DRAWN
 2012

MODEL FORMAT
 .BIM / .SAT

YEAR FIRST MANUFACTURED
 2012

SCALE
 NOT TO SCALE



FIRST ANGLE PROJECTION

COPY RIGHT YEAR
 2019

SIZES
 9.0 X 3.0M

INDEMANDDRAWINGOFFICE.CO.ZA LINK



DRAWING CATEGORY
 RENDER STD-FF009



THE CONTENTS OF THIS DRAWING IS THE SOLE PROPERTY OF IN DEMAND TRADING (PTY) LTD
 AND MAY NOT BE COPIED OR DIVULGED TO ANY THIRD PARTY WITHOUT THE WRITTEN CONSENT
 In Demand Trading (Pty) Ltd | Reg Number: 2014/057552/07 | VAT Number: 4568746



PERSPECTIVE VIEW



TOP VIEW



SIDE VIEW

IN DEMAND TRADING (PTY) LTD
 STEPPING STONES GARDEN VILLAGE
 283 OLD HONEYDEW ROAD WEST
 NORTHRIDING, JHB, GAUTENG, RSA



INDEMANDdrawingoffice.co.za
 Download BIM, DWG and 3D model tensile shade structures

DESCRIPTION

WALL MOUNTED CL HIGH TENSILE WIND RATED UMBRELLA

CATEGORY
 STANDARD STRUCTURE SCL

INDEMANDDRAWINGOFFICE.CO.ZA LINK



DRAWING CATEGORY
 RENDER STD-CL008



FIRST ANGLE PROJECTION

CATEGORY
 STANDARD STRUCTURE

IMAGE FORMAT
 .PNG

SOFTWARE
 AUTODESK INVENTOR

YEAR DRAWN
 2000

YEAR FIRST MANUFACTURED
 2000

COPY RIGHT YEAR
 2019

MEMBRANE OPTIONS
 ARCHITECTURAL PVC

MODEL FORMAT
 .BIM / .SATT

SCALE
 NOT TO SCALE

SIZES
 VARIOUS



THE CONTENTS OF THIS DRAWING IS THE SOLE PROPERTY OF IN DEMAND TRADING (PTY) LTD
 AND MAY NOT BE COPIED OR DIVULGED TO ANY THIRD PARTY WITHOUT THE WRITTEN CONSENT
 In Demand Trading (Pty) Ltd | Reg Number: 2014/057552/07 | VAT Number: 4568746



PERSPECTIVE VIEW

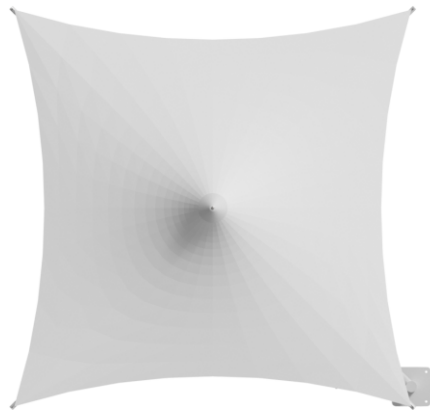

TOP VIEW



SIDE VIEW

IN DEMAND TRADING (PTY) LTD
 STEPPING STONES GARDEN VILLAGE
 283 OLD HONEYDEW ROAD WEST
 NORTHRIDING, JHB, GAUTENG, RSA



INDEMANDdrawingoffice.co.za
 Download BIM, DWG and 3D model tensile shade structures

DESCRIPTION

SINGLE CANTILEVER HIGH TENSILE WIND RATED UMBRELLA

CATEGORY

STANDARD STRUCTURE SCL

CATEGORY

STANDARD STRUCTURE

MEMBRANE OPTIONS

ARCHITECTURAL PVC

IMAGE FORMAT

.PNG

SOFTWARE

AUTODESK INVENTOR

YEAR DRAWN

2000

YEAR FIRST MANUFACTURED

2000

MODEL FORMAT

.BIM / .SAT

SCALE

NOT TO SCALE

COPY RIGHT YEAR

2019

SIZES

VARIOUS

INDEMANDDRAWINGOFFICE.CO.ZA LINK

CLICK HERE

DRAWING CATEGORY

RENDER STD-CL001

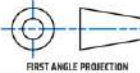

FIRST ANGLE PROJECTION



THE CONTENTS OF THIS DRAWING IS THE SOLE PROPERTY OF IN DEMAND TRADING (PTY) LTD AND MAY NOT BE COPIED OR DIVULGED TO ANY THIRD PARTY WITHOUT THE WRITTEN CONSENT
 In Demand Trading (Pty) Ltd | Reg Number: 2014/057552/07 | VAT Number: 4568746

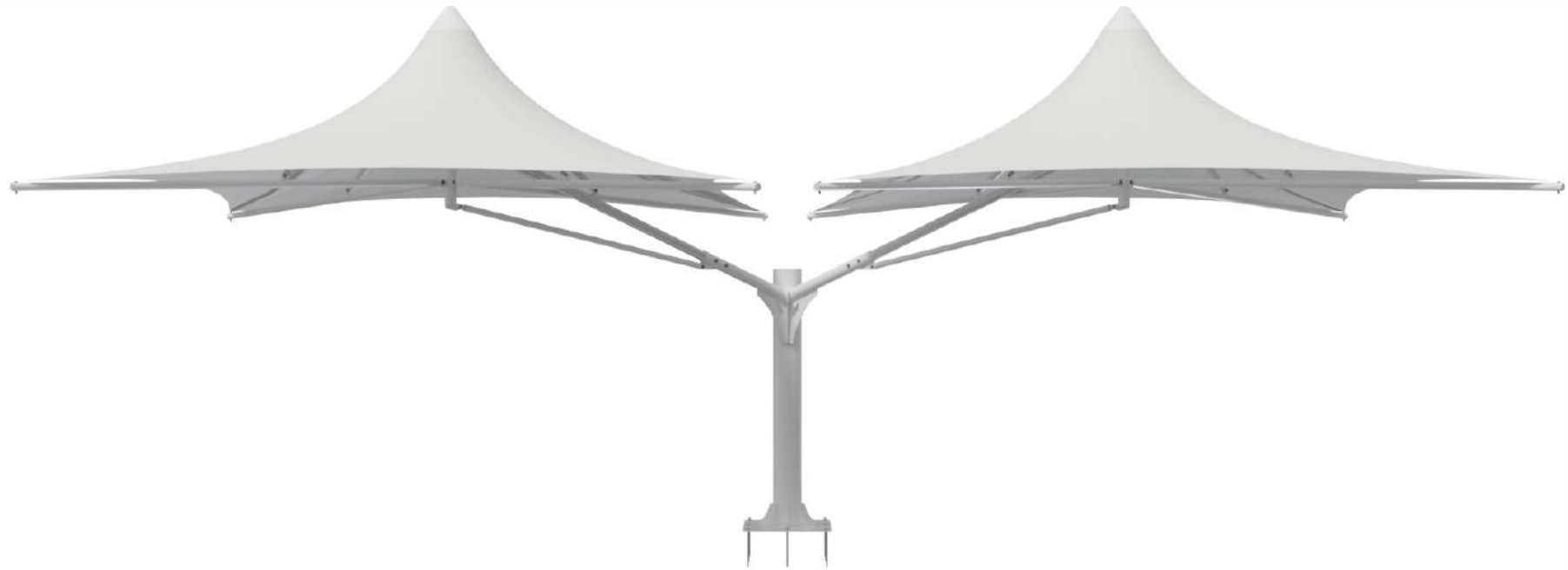

FRONT VIEW



TOP VIEW



SIDE VIEW

IN DEMAND TRADING (PTY) LTD
 STEPPING STONES GARDEN VILLAGE
 283 OLD HONEYDEW ROAD WEST
 NORTHRIDING, JHB, GAUTENG, RSA

T// +27 (0)21 791 1888
 SALES@INDEMANDTRADING.CO.ZA
 WWW.INDEMANDTRADING.CO.ZA



INDEMANDdrawingoffice.co.za
 Download BIM, DWG and 3D model tensile shade structures

DESCRIPTION

DUALCANTILEVER HIGH TENSILE WIND RATED UMBRELLA

CATEGORY

STANDARD STRUCTURE QCL

CATEGORY

STANDARD STRUCTURE

MEMBRANE OPTIONS

ARCHITECTURAL PVC

IMAGE FORMAT

.PNG

SOFTWARE

AUTODESK INVENTOR

YEAR DRAWN

2000

YEAR FIRST MANUFACTURED

2000

MODEL FORMAT

.BIM / .SAT

SCALE

NOT TO SCALE

COPY RIGHT YEAR

2019

SIZES

VARIOUS

INDEMANDDRAWINGOFFICE.CO.ZA LINK

CLICK HERE

DRAWING CATEGORY

RENDER STD-CL002

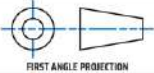

FIRST ANGLE PROJECTION



THE CONTENTS OF THIS DRAWING IS THE SOLE PROPERTY OF IN DEMAND TRADING (PTY) LTD AND MAY NOT BE COPIED, DIVULGED TO ANY THIRD PARTY WITHOUT THE WRITTEN CONSENT
 In Demand Trading (Pty) Ltd | Reg Number: 2014/057552/07 | VAT Number: 4568746



FRONT VIEW

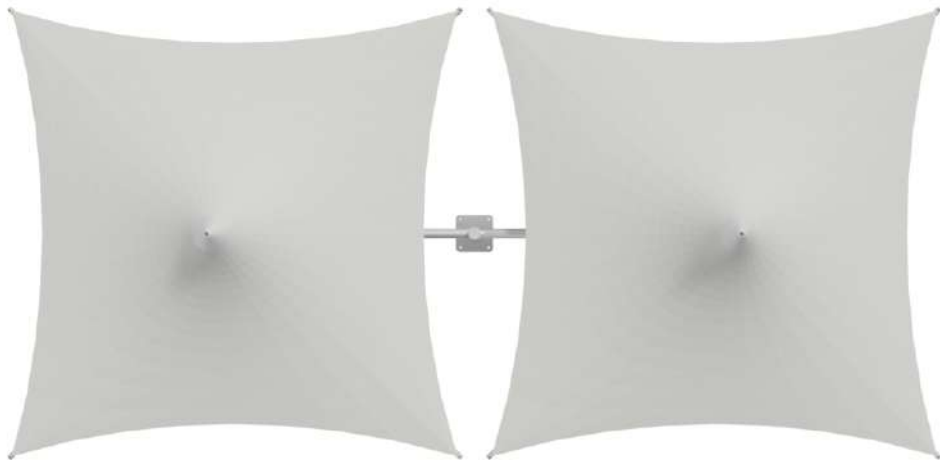

TOP VIEW



SIDE VIEW

IN DEMAND TRADING (PTY) LTD
 STEPPING STONES GARDEN VILLAGE
 283 OLD HONEYDEW ROAD WEST
 NORTHRIDING, JHB, GAUTENG, RSA



INDEMANDdrawingoffice.co.za
 Download BIM, DWG and 3D model tensile shade structures

DESCRIPTION

DUAL CANTILEVER HIGH TENSILE WIND RATED UMBRELLA

CATEGORY

STANDARD STRUCTURE- VITRUVIAN

CATEGORY

STANDARD STRUCTURE

MEMBRANE OPTIONS

ARCHITECTURAL PVC

IMAGE FORMAT

.PNG

SOFTWARE

AUTODESK INVENTOR

YEAR DRAWN

2012

YEAR FIRST MANUFACTURED

2012

MODEL FORMAT

.BIM / .SAT

SCALE

NOT TO SCALE

COPY RIGHT YEAR

2019

SIZES

VARIOUS

INDEMANDDRAWINGOFFICE.CO.ZA LINK

CLICK HERE

DRAWING CATEGORY

RENDER STD-V1001



FIRST ANGLE PROJECTION



THE CONTENTS OF THIS DRAWING IS THE SOLE PROPERTY OF IN DEMAND TRADING (PTY) LTD
 AND MAY NOT BE COPIED OR DIVULGED TO ANY THIRD PARTY WITHOUT THE WRITTEN CONSENT
 In Demand Trading (Pty) Ltd | Reg Number: 2014/057552/07 | VAT Number: 4568746



FRONT VIEW



TOP VIEW



SIDE VIEW

IN DEMAND TRADING (PTY) LTD
 STEPPING STONES GARDEN VILLAGE
 283 OLD HONEYDEW ROAD WEST
 NORTHRIDING, JHB, GAUTENG, RSA



INDEMANDdrawingoffice.co.za
 Download BIM, DWG and 3D model tensile shade structures

DESCRIPTION

TRI CANTILEVER HIGH TENSILE WIND RATED UMBRELLA

CATEGORY
 STANDARD STRUCTURE QCL

CATEGORY
 STANDARD STRUCTURE

MEMBRANE OPTIONS
 ARCHITECTURAL PVC

IMAGE FORMAT
 .PNG

SOFTWARE
 AUTODESK INVENTOR

YEAR DRAWN
 2000

MODEL FORMAT
 .BIM / .SAT

YEAR FIRST MANUFACTURED
 2000

SCALE
 NOT TO SCALE



FIRST ANGLE PROJECTION

COPY RIGHT YEAR
 2019

SIZES
 VARIOUS

INDEMANDDRAWINGOFFICE.CO.ZA LINK



DRAWING CATEGORY
 RENDER STD-CL009



THE CONTENTS OF THIS DRAWING IS THE SOLE PROPERTY OF IN DEMAND TRADING (PTY) LTD
 AND MAY NOT BE COPIED OR DIVULGED TO ANY THIRD PARTY WITHOUT THE WRITTEN CONSENT
 In Demand Trading (Pty) Ltd | Reg Number: 2014/057552/07 | VAT Number: 4568746

T// +27 (0)21 791 1888
 SALES@INDEMANDTRADING.CO.ZA
 WWW.INDEMANDTRADING.CO.ZA



PERSPECTIVE VIEW

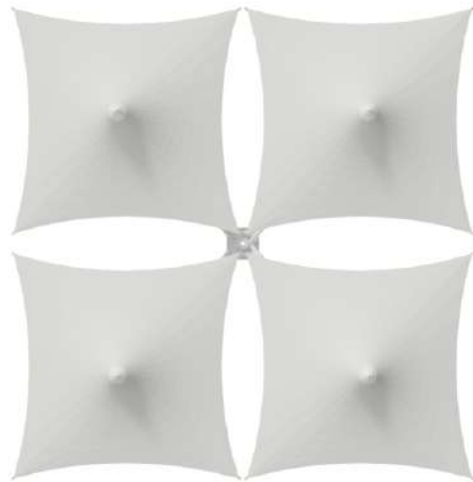

TOP VIEW

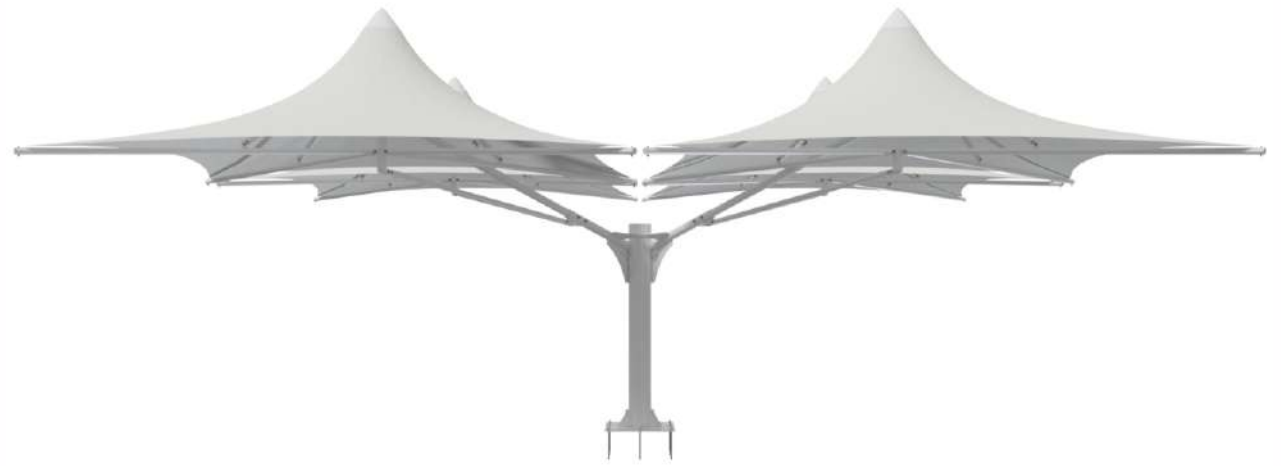

FRONT VIEW

IN DEMAND TRADING (PTY) LTD
 STEPPING STONES GARDEN VILLAGE
 283 OLD HONEYDEW ROAD WEST
 NORTHRIDING, JHB, GAUTENG, RSA

T: // +27 (0)21 791 1888
 SALES@INDEMANDTRADING.CO.ZA
 WWW.INDEMANDTRADING.CO.ZA



INDEMANDdrawingoffice.co.za
 Download BIM, DWG and 3D model tensile shade structures

DESCRIPTION

QUAD CANTILEVER HIGH TENSILE WIND RATED UMBRELLA

CATEGORY

STANDARD STRUCTURE QCL

CATEGORY

STANDARD STRUCTURE

MEMBRANE OPTIONS

ARCHITECTURAL PVC

IMAGE FORMAT

.PNG

SOFTWARE

AUTODESK INVENTOR

YEAR DRAWN

2000

YEAR FIRST MANUFACTURED

2000

MODEL FORMAT

.BIM / .SAT

SCALE

NOT TO SCALE

COPY RIGHT YEAR

2019

SIZES

VARIOUS

INDEMANDDRAWINGOFFICE.CO.ZA LINK

CLICK HERE

DRAWING CATEGORY

RENDER STD-CL004



FIRST ANGLE PROJECTION



THE CONTENTS OF THIS DRAWING IS THE SOLE PROPERTY OF IN DEMAND TRADING (PTY) LTD
 AND MAY NOT BE COPIED OR DIVULGED TO ANY THIRD PARTY WITHOUT THE WRITTEN CONSENT
 In Demand Trading (Pty) Ltd | Reg Number: 2014/057552/07 | VAT Number: 4568746



PERSPECTIVE



TOP VIEW



FRONT VIEW



SIDE VIEW

IN DEMAND TRADING (PTY) LTD
 STEPPING STONES GARDEN VILLAGE
 283 OLD HONEYDEW ROAD WEST
 NORTHRIDING, JHB, GAUTENG, RSA

T// +27 (0)21 791 1888
 SALES@INDEMANDTRADING.CO.ZA
 WWW.INDEMANDTRADING.CO.ZA



INDEMANDdrawingoffice.co.za
 Download BIM, DWG and 3D model tensile shade structures

DESCRIPTION

BIRD STRUCTURE

CATEGORY

STANDARD STRUCTURE

CATEGORY

STANDARD STRUCTURE

MEMBRANE OPTIONS

ARCHITECTURAL PVC, THERMOFLEX, SHADECLOTH

IMAGE FORMAT

.PNG

SOFTWARE

AUTODESK INVENTOR

YEAR DRAWN

2012

YEAR FIRST MANUFACTURED

2012

MODEL FORMAT

.BIM / .SAT

SCALE

NOT TO SCALE

COPY RIGHT YEAR

2012

SIZES

VARIOUS

INDEMANDDRAWINGOFFICE.CO.ZA LINK

CLICK HERE

DRAWING CATEGORY

RENDER STD-B1001

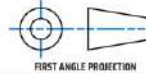

FIRST ANGLE PROJECTION



THE CONTENTS OF THIS DRAWING IS THE SOLE PROPERTY OF IN DEMAND TRADING (PTY) LTD
 AND MAY NOT BE COPIED OR DIVULGED TO ANY THIRD PARTY WITHOUT THE WRITTEN CONSENT
 In Demand Trading (Pty) Ltd | Reg Number: 2014/057552/07 | VAT Number: 4568746

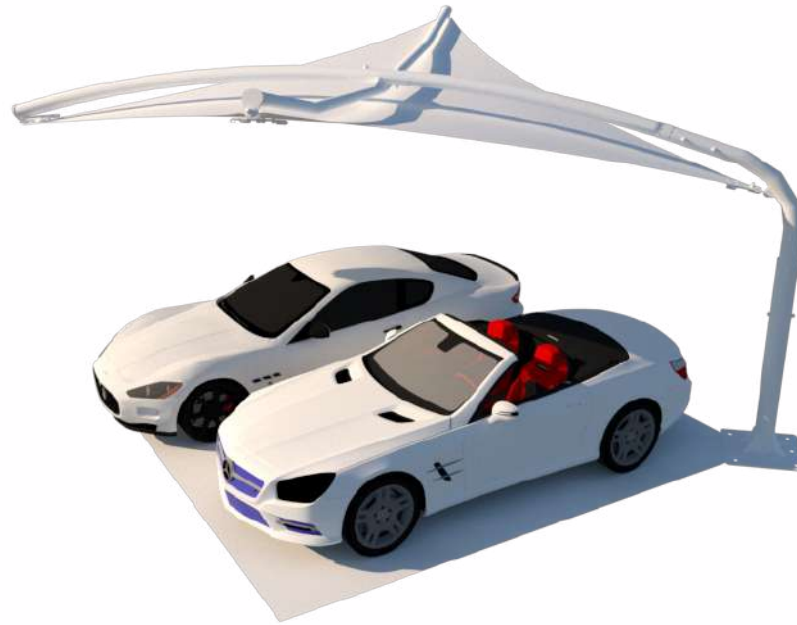

PERSPECTIVE



TOP VIEW



FRONT VIEW



SIDE VIEW

IN DEMAND TRADING (PTY) LTD
 STEPPING STONES GARDEN VILLAGE
 283 OLD HONEYDEW ROAD WEST
 NORTHRIDING, JHB, GAUTENG, RSA



INDEMANDdrawingoffice.co.za
 Download BIM, DWG and 3D model tensile shade structures

DESCRIPTION

BIRDPORT STRUCTURE

CATEGORY

STANDARD STRUCTURE

CATEGORY

STANDARD STRUCTURE

MEMBRANE OPTIONS:

ARCHITECTURAL PVC, THERMOFLEX, SHADECLOTH

IMAGE FORMAT

.PNG

SOFTWARE

AUTODESK INVENTOR

YEAR DRAWN

2012

YEAR FIRST MANUFACTURED

2012

COPY RIGHT YEAR

2012

MODEL FORMAT

.BIM / .SAT

SCALE

NOT TO SCALE

SIZES

VARIOUS

INDEMANDDRAWINGOFFICE.CO.ZA LINK

CLICK HERE

DRAWING CATEGORY

RENDER STD-BI004



FIRST ANGLE PROJECTION



THE CONTENTS OF THIS DRAWING IS THE SOLE PROPERTY OF IN DEMAND TRADING (PTY) LTD AND MAY NOT BE COPIED, DIVULGED TO ANY THIRD PARTY WITHOUT THE WRITTEN CONSENT
 In Demand Trading (Pty) Ltd | Reg Number: 2014/057552/07 | VAT Number: 4568746

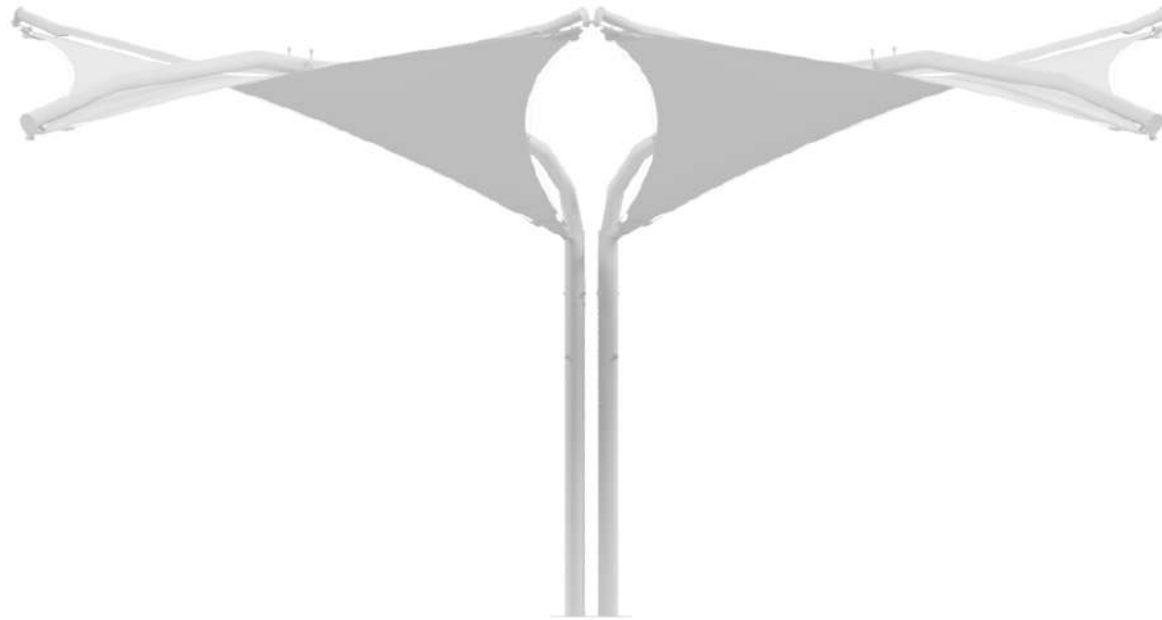

PERSPECTIVE



TOP VIEW



FRONT VIEW

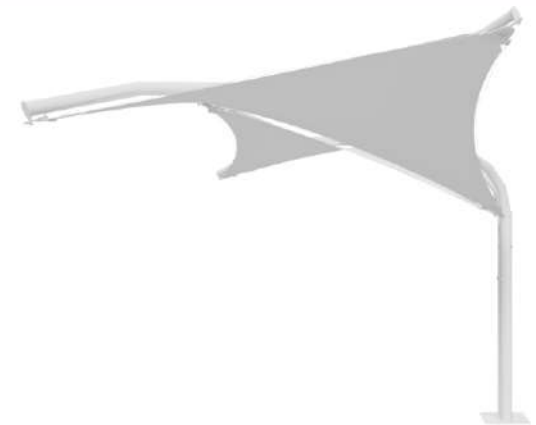

SIDE VIEW

IN DEMAND TRADING (PTY) LTD
 STEPPING STONES GARDEN VILLAGE
 283 OLD HONEYDEW ROAD WEST
 NORTHRIDING, JHB, GAUTENG, RSA

T// +27 (0)21 791 1888
 SALES@INDEMANDTRADING.CO.ZA
 WWW.INDEMANDTRADING.CO.ZA



INDEMANDdrawingoffice.co.za
 Download BIM, DWG and 3D model tensile shade structures

DESCRIPTION

BIRD DUAL STRUCTURE

CATEGORY

STANDARD STRUCTURE

CATEGORY

STANDARD STRUCTURE

MEMBRANE OPTIONS

ARCHITECTURAL PVC, THERMOFLEX, SHADECLOTH

IMAGE FORMAT

.PNG

SOFTWARE

AUTODESK INVENTOR

YEAR DRAWN

2012

YEAR FIRST MANUFACTURED

2012

MODEL FORMAT

.BIM / .SAT

SCALE

NOT TO SCALE

COPY RIGHT YEAR

2012

SIZES

VARIOUS

INDEMANDDRAWINGOFFICE.CO.ZA LINK

CLICK HERE

DRAWING CATEGORY

RENDER STD-BI002



FIRST ANGLE PROJECTION



THE CONTENTS OF THIS DRAWING IS THE SOLE PROPERTY OF IN DEMAND TRADING (PTY) LTD
 AND MAY NOT BE COPIED OR DIVULGED TO ANY THIRD PARTY WITHOUT THE WRITTEN CONSENT
 In Demand Trading (Pty) Ltd | Reg Number: 2014/057552/07 | VAT Number: 4568746

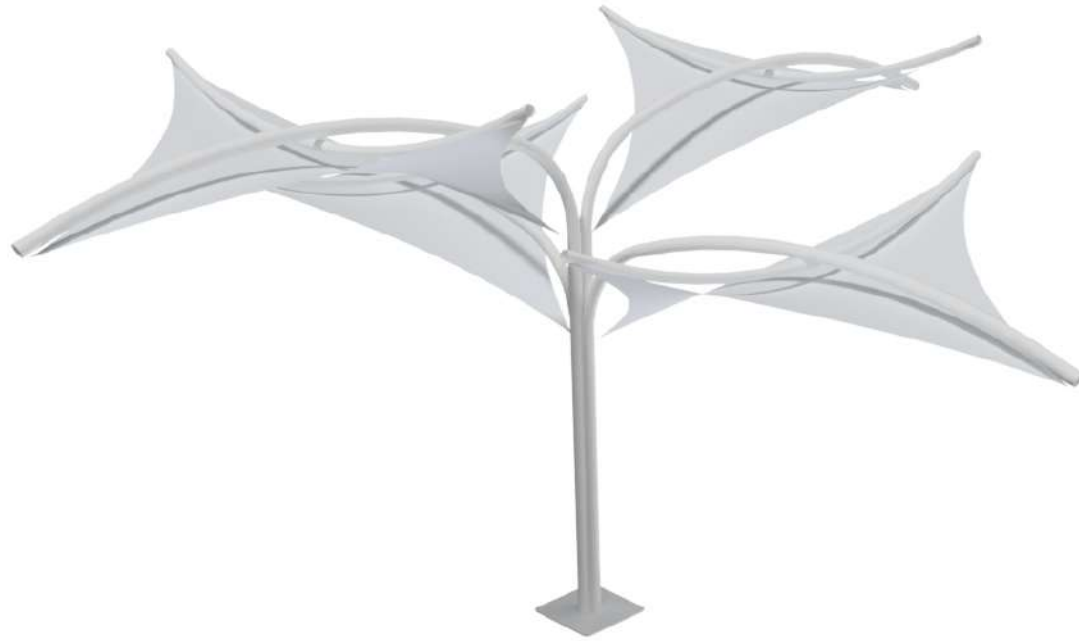

PERSPECTIVE

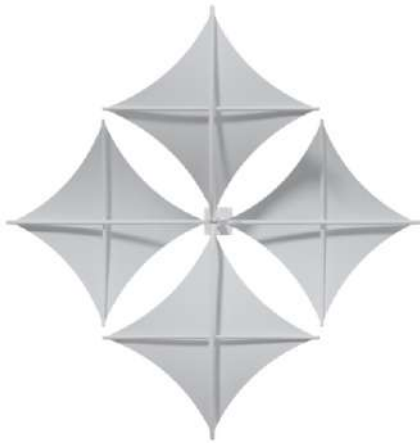

TOP VIEW



FRONT VIEW



SIDE VIEW

IN DEMAND TRADING (PTY) LTD
 STEPPING STONES GARDEN VILLAGE
 283 OLD HONEYDEW ROAD WEST
 NORTHRIDING, JHB, GAUTENG, RSA



INDEMANDdrawingoffice.co.za
 Download BIM, DWG and 3D model tensile shade structures

DESCRIPTION

BIRD STRUCTURE QUAD

CATEGORY

STANDARD STRUCTURE

CATEGORY

STANDARD STRUCTURE

MEMBRANE OPTIONS

ARCHITECTURAL PVC, THERMOFLEX, SHADECLOTH

IMAGE FORMAT

.PNG

SOFTWARE

AUTODESK INVENTOR

YEAR DRAWN

2012

YEAR FIRST MANUFACTURED

2012

MODEL FORMAT

.BIM / .SAT

SCALE

NOT TO SCALE

COPY RIGHT YEAR

2012

SIZES

VARIOUS

INDEMANDDRAWINGOFFICE.CO.ZA LINK

CLICK HERE

DRAWING CATEGORY

RENDER STD-BI002

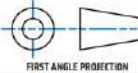

FIRST ANGLE PROJECTION



THE CONTENTS OF THIS DRAWING IS THE SOLE PROPERTY OF IN DEMAND TRADING (PTY) LTD AND MAY NOT BE COPIED OR DIVULGED TO ANY THIRD PARTY WITHOUT THE WRITTEN CONSENT
 In Demand Trading (Pty) Ltd | Reg Number: 2014/057552/07 | VAT Number: 4568746



PERSPECTIVE



TOP VIEW



FRONT VIEW



SIDE VIEW

IN DEMAND TRADING (PTY) LTD
 STEPPING STONES GARDEN VILLAGE
 283 OLD HONEYDEW ROAD WEST
 NORTHRIDING, JHB, GAUTENG, RSA

T// +27 (0)21 791 1888
 SALES@INDEMANDTRADING.CO.ZA
 WWW.INDEMANDTRADING.CO.ZA



INDEMANDdrawingoffice.co.za
 Download BIM, DWG and 3D model tensile shade structures

DESCRIPTION

CENTRE POST HYPAR TENSION ROD

CATEGORY
 STANDARD STRUCTURE

CATEGORY
 STANDARD STRUCTURE

MEMBRANE OPTIONS

ARCHITECTURAL PVC, THERMOFLEX, SHADECLOTH

IMAGE FORMAT
 .PNG

SOFTWARE

AUTODESK INVENTOR

YEAR DRAWN
 2012

MODEL FORMAT
 .BIM / .SATT

YEAR FIRST MANUFACTURED
 2012

SCALE
 NOT TO SCALE

COPY RIGHT YEAR
 2012

SIZES
 VARIOUS

INDEMANDDRAWINGOFFICE.CO.ZA LINK

CLICK HERE

DRAWING CATEGORY
 RENDER STD-HY002

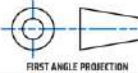

FIRST ANGLE PROJECTION



THE CONTENTS OF THIS DRAWING IS THE SOLE PROPERTY OF IN DEMAND TRADING (PTY) LTD
 AND MAY NOT BE COPIED OR DIVULGED TO ANY THIRD PARTY WITHOUT THE WRITTEN CONSENT
 In Demand Trading (Pty) Ltd | Reg Number: 2014/057552/07 | VAT Number: 4568746



PERSPECTIVE



TOP VIEW



FRONT VIEW



SIDE VIEW

IN DEMAND TRADING (PTY) LTD
 STEPPING STONES GARDEN VILLAGE
 283 OLD HONEYDEW ROAD WEST
 NORTHRIDING, JHB, GAUTENG, RSA



INDEMANDdrawingoffice.co.za
 Download BIM, DWG and 3D model tensile shade structures

DESCRIPTION

CENTRE POST HYPARPORT TENSION ROD

CATEGORY
 STANDARD STRUCTURE

CATEGORY
 STANDARD STRUCTURE

MEMBRANE OPTIONS

ARCHITECTURAL PVC, THERMOFLEX, SHADECLOTH

IMAGE FORMAT
 .PNG

SOFTWARE

AUTODESK INVENTOR

YEAR DRAWN
 2012

MODEL FORMAT
 .BIM / .SATT

YEAR FIRST MANUFACTURED
 2012

SCALE
 NOT TO SCALE



FIRST ANGLE PROJECTION

COPY RIGHT YEAR
 2012

SIZES
 VARIOUS

INDEMANDDRAWINGOFFICE.CO.ZA LINK



DRAWING CATEGORY
 RENDER STD-HY003



THE CONTENTS OF THIS DRAWING IS THE SOLE PROPERTY OF IN DEMAND TRADING (PTY) LTD
 AND MAY NOT BE COPIED OR DIVULGED TO ANY THIRD PARTY WITHOUT THE WRITTEN CONSENT
 In Demand Trading (Pty) Ltd | Reg Number: 2014/057552/07 | VAT Number: 4568746

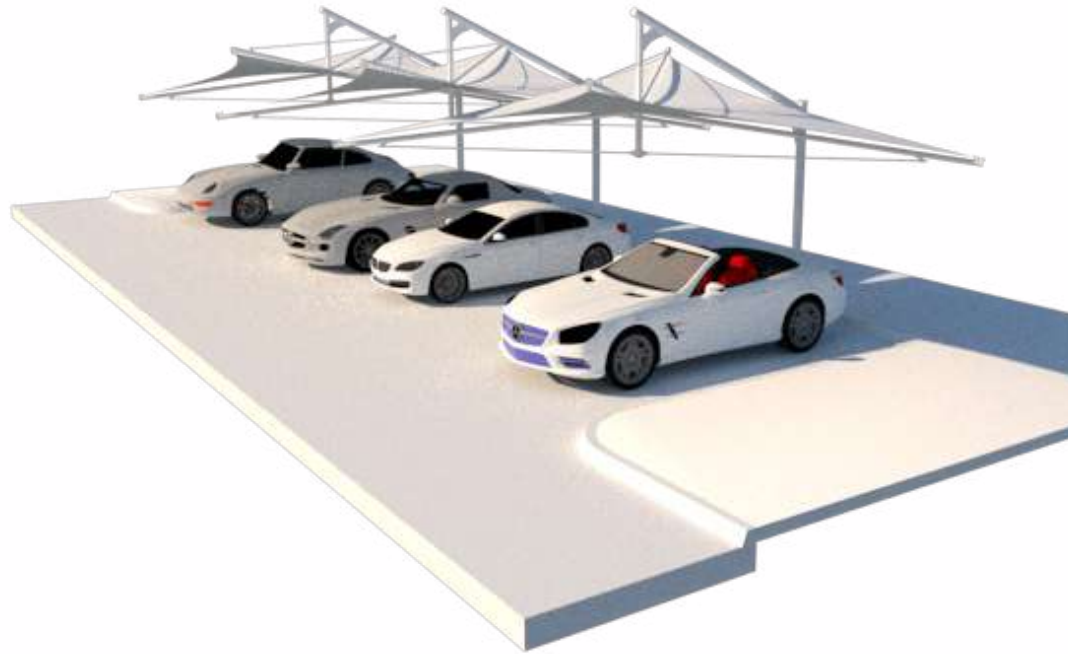

PERSPECTIVE VIEW



TOP VIEW



FRONT VIEW



SIDE VIEW

IN DEMAND TRADING (PTY) LTD
 STEPPING STONES GARDEN VILLAGE
 283 OLD HONEYDEW ROAD WEST
 NORTHRIDING, JHB, GAUTENG, RSA



INDEMANDdrawingoffice.co.za
 Download BIM, DWG and 3D model tensile shade structures

DESCRIPTION

CANTILEVER HYPARPORT TENSION ROD

CATEGORY

STANDARD STRUCTURE

CATEGORY

STANDARD STRUCTURE

MEMBRANE OPTIONS:

SHADECLOTH, ARCHITECTURAL PVC AND THERMOFLEX

IMAGE FORMAT

.PNG

SOFTWARE

AUTODESK INVENTOR

YEAR DRAWN

2020

YEAR FIRST MANUFACTURED

2020

MODEL FORMAT

.BIM / .SAT

SCALE

NOT TO SCALE

COPY RIGHT YEAR

2019

SIZES

VARIOUS

INDEMANDDRAWINGOFFICE.CO.ZA LINK

CLICK HERE

DRAWING CATEGORY

RENDER ST - CH003

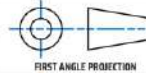

FIRST ANGLE PROJECTION



THE CONTENTS OF THIS DRAWING IS THE SOLE PROPERTY OF IN DEMAND TRADING (PTY) LTD
 AND MAY NOT BE COPIED OR DIVULGED TO ANY THIRD PARTY WITHOUT THE WRITTEN CONSENT
 In Demand Trading (Pty) Ltd | Reg Number: 2014/057552/07 | VAT Number: 4568746



PERSPECTIVE



TOP VIEW



FRONT VIEW



SIDE VIEW

IN DEMAND TRADING (PTY) LTD
 STEPPING STONES GARDEN VILLAGE
 283 OLD HONEYDEW ROAD WEST
 NORTHRIDING, JHB, GAUTENG, RSA



INDEMANDdrawingoffice.co.za
 Download BIM, DWG and 3D model tensile shade structures

DESCRIPTION

HYPAR STRUCTURE

CATEGORY
 STANDARD STRUCTURE

CATEGORY
 STANDARD STRUCTURE

MEMBRANE OPTIONS

ARCHITECTURAL PVC, THERMOFLEX, SHADECLOTH

IMAGE FORMAT

.PNG

SOFTWARE

AUTODESK INVENTOR

YEAR DRAWN

2012

YEAR FIRST MANUFACTURED

2012

MODEL FORMAT

.BIM / .SAT

SCALE

NOT TO SCALE

COPY RIGHT YEAR

2012

SIZES

VARIOUS

INDEMANDDRAWINGOFFICE.CO.ZA LINK

CLICK HERE

DRAWING CATEGORY

RENDER STD-HY001



FIRST ANGLE PROJECTION



THE CONTENTS OF THIS DRAWING IS THE SOLE PROPERTY OF IN DEMAND TRADING (PTY) LTD AND MAY NOT BE COPIED OR DIVULGED TO ANY THIRD PARTY WITHOUT THE WRITTEN CONSENT
 In Demand Trading (Pty) Ltd | Reg Number: 2014/057552/07 | VAT Number: 4568746



PERSPECTIVE



TOP VIEW



FRONT VIEW



SIDE VIEW

IN DEMAND TRADING (PTY) LTD
 STEPPING STONES GARDEN VILLAGE
 283 OLD HONEYDEW ROAD WEST
 NORTHRIDING, JHB, GAUTENG, RSA

T// +27 (0)21 791 1888
 SALES@INDEMANDTRADING.CO.ZA
 WWW.INDEMANDTRADING.CO.ZA



INDEMANDdrawingoffice.co.za
 Download BIM, DWG and 3D model tensile shade structures

DESCRIPTION

HYPAR LITE STRUCTURE

CATEGORY

STANDARD STRUCTURE

CATEGORY

STANDARD STRUCTURE

MEMBRANE OPTIONS

ARCHITECTURAL PVC, THERMOFLEX, SHADECLOTH

IMAGE FORMAT

.PNG

SOFTWARE

AUTODESK INVENTOR

YEAR DRAWN

2012

YEAR FIRST MANUFACTURED

2012

MODEL FORMAT

.BIM / .SAT

SCALE

NOT TO SCALE

SIZES

VARIOUS

INDEMANDDRAWINGOFFICE.CO.ZA LINK

CLICK HERE

DRAWING CATEGORY

RENDER STD-HY004

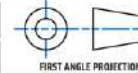

FIRST ANGLE PROJECTION



THE CONTENTS OF THIS DRAWING IS THE SOLE PROPERTY OF IN DEMAND TRADING (PTY) LTD
 AND MAY NOT BE COPIED, DIVULGED TO ANY THIRD PARTY WITHOUT THE WRITTEN CONSENT
 In Demand Trading (Pty) Ltd | Reg Number: 2014/057552/07 | VAT Number: 4568746



PERSPECTIVE



TOP VIEW



FRONT VIEW



SIDE VIEW

IN DEMAND TRADING (PTY) LTD
 STEPPING STONES GARDEN VILLAGE
 283 OLD HONEYDEW ROAD WEST
 NORTHRIDING, JHB, GAUTENG, RSA



INDEMANDdrawingoffice.co.za
 Download BIM, DWG and 3D model tensile shade structures

DESCRIPTION

HYPARPORT LITE STRUCTURE

CATEGORY
 STANDARD STRUCTURE

CATEGORY
 STANDARD STRUCTURE

MEMBRANE OPTIONS:

ARCHITECTURAL PVC, THERMOFLEX, SHADECLOTH

IMAGE FORMAT

.PNG

SOFTWARE

AUTODESK INVENTOR

YEAR DRAWN

2012

MODEL FORMAT

.BIM / .SAT

YEAR FIRST MANUFACTURED

2012

SCALE

NOT TO SCALE



COPY RIGHT YEAR

2012

SIZES

VARIOUS

INDEMANDDRAWINGOFFICE.CO.ZA LINK

CLICK HERE

DRAWING CATEGORY

RENDER STD-HY005



THE CONTENTS OF THIS DRAWING IS THE SOLE PROPERTY OF IN DEMAND TRADING (PTY) LTD
 AND MAY NOT BE COPIED OR DIVULGED TO ANY THIRD PARTY WITHOUT THE WRITTEN CONSENT
 In Demand Trading (Pty) Ltd | Reg Number: 2014/057552/07 | VAT Number: 4568746



PERSPECTIVE



TOP VIEW



FRONT VIEW



SIDE VIEW

IN DEMAND TRADING (PTY) LTD
 STEPPING STONES GARDEN VILLAGE
 283 OLD HONEYDEW ROAD WEST
 NORTHRIDING, JHB, GAUTENG, RSA



INDEMANDdrawingoffice.co.za
 Download BIM, DWG and 3D model tensile shade structures

DESCRIPTION

CANTILEVER HYPARPORT LITE STRUCTURE

CATEGORY
 STANDARD STRUCTURE

CATEGORY
 STANDARD STRUCTURE

MEMBRANE OPTIONS:

ARCHITECTURAL PVC, THERMOFLEX, SHADECLOTH

IMAGE FORMAT
 .PNG

SOFTWARE
 AUTODESK INVENTOR

YEAR DRAWN
 2012

MODEL FORMAT

.BIM / .SATT

YEAR FIRST MANUFACTURED
 2012

SCALE

NOT TO SCALE



FIRST ANGLE PROJECTION

COPY RIGHT YEAR
 2012

SIZES

VARIOUS

INDEMANDDRAWINGOFFICE.CO.ZA LINK



DRAWING CATEGORY

RENDER STD-HY005



THE CONTENTS OF THIS DRAWING IS THE SOLE PROPERTY OF IN DEMAND TRADING (PTY) LTD
 AND MAY NOT BE COPIED OR DIVULGED TO ANY THIRD PARTY WITHOUT THE WRITTEN CONSENT
 In Demand Trading (Pty) Ltd | Reg Number: 2014/057552/07 | VAT Number: 4568746



PERSPECTIVE

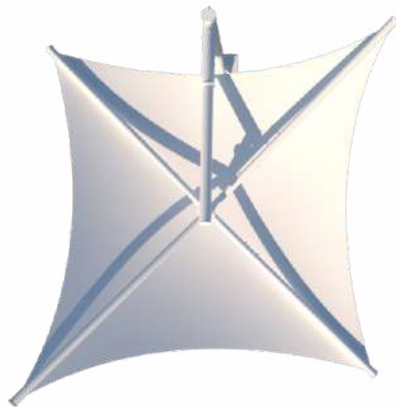

TOP VIEW



FRONT VIEW



SIDE VIEW

IN DEMAND TRADING (PTY) LTD
 STEPPING STONES GARDEN VILLAGE
 283 OLD HONEYDEW ROAD WEST
 NORTHRIDING, JHB, GAUTENG, RSA



INDEMANDdrawingoffice.co.za
 Download BIM, DWG and 3D model tensile shade structures

DESCRIPTION

CANTILEVER HYPAR LITE STRUCTURE

CATEGORY

STANDARD STRUCTURE

CATEGORY

STANDARD STRUCTURE

MEMBRANE OPTIONS

ARCHITECTURAL PVC, THERMOFLEX, SHADECLOTH

IMAGE FORMAT

.PNG

SOFTWARE

AUTODESK INVENTOR

YEAR DRAWN

2020

YEAR FIRST MANUFACTURED

2020

MODEL FORMAT

.BIM / .SATT

SCALE

NOT TO SCALE

COPY RIGHT YEAR

2020

SIZES

VARIOUS

INDEMANDDRAWINGOFFICE.CO.ZA LINK

CLICK HERE

DRAWING CATEGORY

RENDER STD-HY006

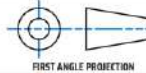

FIRST ANGLE PROJECTION



THE CONTENTS OF THIS DRAWING IS THE SOLE PROPERTY OF IN DEMAND TRADING (PTY) LTD
 AND MAY NOT BE COPIED, DIVULGED TO ANY THIRD PARTY WITHOUT THE WRITTEN CONSENT
 In Demand Trading (Pty) Ltd | Reg Number: 2014/057552/07 | VAT Number: 4568746



PERSPECTIVE



TOP VIEW



FRONT VIEW



SIDE VIEW

IN DEMAND TRADING (PTY) LTD
 STEPPING STONES GARDEN VILLAGE
 283 OLD HONEYDEW ROAD WEST
 NORTHRIDING, JHB, GAUTENG, RSA



INDEMANDdrawingoffice.co.za
 Download BIM, DWG and 3D model tensile shade structures

DESCRIPTION

HYPAR STRUCTURE FREE STANDING

CATEGORY
 STANDARD STRUCTURE

CATEGORY
 STANDARD STRUCTURE

MEMBRANE OPTIONS

ARCHITECTURAL PVC, THERMOFLEX, SHADECLOTH

IMAGE FORMAT

.PNG

SOFTWARE

AUTODESK INVENTOR

YEAR DRAWN

2016

YEAR FIRST MANUFACTURED

2016

MODEL FORMAT

.BIM / .SAT

SCALE

NOT TO SCALE

COPY RIGHT YEAR

2016

SIZES

VARIOUS

INDEMANDDRAWINGOFFICE.CO.ZA LINK

CLICK HERE

DRAWING CATEGORY

RENDER STD-HY002

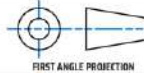

FIRST ANGLE PROJECTION



THE CONTENTS OF THIS DRAWING IS THE SOLE PROPERTY OF IN DEMAND TRADING (PTY) LTD
 AND MAY NOT BE COPIED OR DIVULGED TO ANY THIRD PARTY WITHOUT THE WRITTEN CONSENT
 In Demand Trading (Pty) Ltd | Reg Number: 2014/057552/07 | VAT Number: 4568746

T: // +27 (0)21 791 1888
 SALES@INDEMANDTRADING.CO.ZA
 WWW.INDEMANDTRADING.CO.ZA



PERSPECTIVE



TOP VIEW



FRONT VIEW



SIDE VIEW

IN DEMAND TRADING (PTY) LTD
 STEPPING STONES GARDEN VILLAGE
 283 OLD HONEYDEW ROAD WEST
 NORTHRIDING, JHB, GAUTENG, RSA



INDEMANDdrawingoffice.co.za
 Download BIM, DWG and 3D model tensile shade structures

DESCRIPTION

ALFRESCO HIGH TENSILE WIND RATED UMBRELLA

CATEGORY

STANDARD STRUCTURE

CATEGORY

STANDARD STRUCTURE

MEMBRANE OPTIONS

ARCHITECTURAL PVC

IMAGE FORMAT

.PNG

SOFTWARE

AUTODESK INVENTOR

YEAR DRAWN

2014

YEAR FIRST MANUFACTURED

2014

MODEL FORMAT

.BIM / .SAT

SCALE

NOT TO SCALE

COPY RIGHT YEAR

2019

SIZES

VARIOUS

INDEMANDDRAWINGOFFICE.CO.ZA LINK

CLICK HERE

DRAWING CATEGORY

RENDER STD-AF001



FIRST ANGLE PROJECTION



THE CONTENTS OF THIS DRAWING IS THE SOLE PROPERTY OF IN DEMAND TRADING (PTY) LTD AND MAY NOT BE COPIED OR DIVULGED TO ANY THIRD PARTY WITHOUT THE WRITTEN CONSENT
 In Demand Trading (Pty) Ltd | Reg Number: 2014/057552/07 | VAT Number: 4568746



PERSPECTIVE VIEW



TOP VIEW



FRONT VIEW



SIDE VIEW

IN DEMAND TRADING (PTY) LTD
 STEPPING STONES GARDEN VILLAGE
 283 OLD HONEYDEW ROAD WEST
 NORTHRIDING, JHB, GAUTENG, RSA



INDEMANDdrawingoffice.co.za
 Download BIM, DWG and 3D model tensile shade structures

DESCRIPTION

SUNSADELL STRUCTURE

CATEGORY

STANDARD STRUCTURE

CATEGORY

STANDARD STRUCTURE

MEMBRANE OPTIONS:

ARCHITECTURAL PVC, THERMOFLEX AND SHADECLOTH

IMAGE FORMAT

.PNG

SOFTWARE

AUTODESK INVENTOR

YEAR DRAWN

2018

YEAR FIRST MANUFACTURED

2018

COPY RIGHT YEAR

2019

MODEL FORMAT

.BIM / .SATT

SCALE

NOT TO SCALE

SIZES

VARIOUS

INDEMANDDRAWINGOFFICE.CO.ZA LINK

CLICK HERE

DRAWING CATEGORY

RENDER STD-SU001



FIRST ANGLE PROJECTION



THE CONTENTS OF THIS DRAWING IS THE SOLE PROPERTY OF IN DEMAND TRADING (PTY) LTD AND MAY NOT BE COPIED OR DIVULGED TO ANY THIRD PARTY WITHOUT THE WRITTEN CONSENT
 In Demand Trading (Pty) Ltd | Reg Number: 2014/057552/07 | VAT Number: 4568746

T// +27 (0)21 791 1888
 SALES@INDEMANDTRADING.CO.ZA
 WWW.INDEMANDTRADING.CO.ZA



PERSPECTIVE VIEW



TOP VIEW

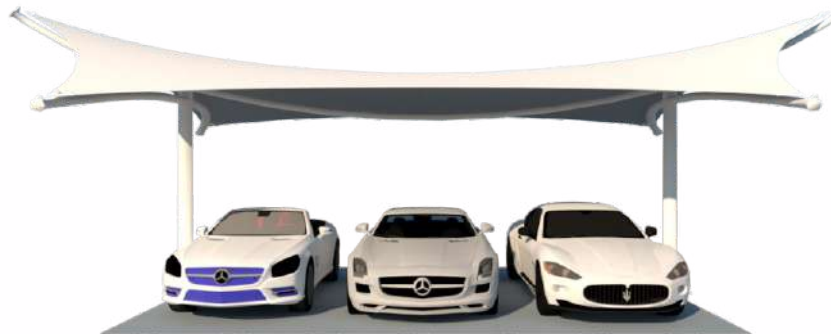

FRONT VIEW



SIDE VIEW

IN DEMAND TRADING (PTY) LTD
 STEPPING STONES GARDEN VILLAGE
 283 OLD HONEYDEW ROAD WEST
 NORTHRIDING, JHB, GAUTENG, RSA



INDEMANDdrawingoffice.co.za
 Download BIM, DWG and 3D model tensile shade structures

DESCRIPTION

SUNSADDLEPORT STRUCTURE

CATEGORY
 STANDARD STRUCTURE

CATEGORY
 STANDARD STRUCTURE

MEMBRANE OPTIONS:

ARCHITECTURAL PVC, THERMOFLEX AND SHADECLOTH

IMAGE FORMAT

.PNG

SOFTWARE

AUTODESK INVENTOR

YEAR DRAWN

2018

MODEL FORMAT
 .BIM / .SAT

YEAR FIRST MANUFACTURED

2018

SCALE
 NOT TO SCALE

COPY RIGHT YEAR

2019

SIZES
 VARIOUS

INDEMANDDRAWINGOFFICE.CO.ZA LINK

CLICK HERE

DRAWING CATEGORY

RENDER STD-SU002



FIRST ANGLE PROJECTION



THE CONTENTS OF THIS DRAWING IS THE SOLE PROPERTY OF IN DEMAND TRADING (PTY) LTD AND MAY NOT BE COPIED OR DIVULGED TO ANY THIRD PARTY WITHOUT THE WRITTEN CONSENT
 In Demand Trading (Pty) Ltd | Reg Number: 2014/057552/07 | VAT Number: 4568746



PERSPECTIVE VIEW



TOP VIEW



FRONT VIEW



SIDE VIEW

IN DEMAND TRADING (PTY) LTD
 STEPPING STONES GARDEN VILLAGE
 283 OLD HONEYDEW ROAD WEST
 NORTHRIDING, JHB, GAUTENG, RSA



INDEMANDdrawingoffice.co.za
 Download BIM, DWG and 3D model tensile shade structures

DESCRIPTION

CARACAU

CATEGORY
 STANDARD STRUCTURE

CATEGORY
 STANDARD STRUCTURE

MEMBRANE OPTIONS
 ARCHITECTURAL PVC AND THERMOFLEX

IMAGE FORMAT

.PNG

SOFTWARE

AUTODESK INVENTOR

YEAR DRAWN

2010

YEAR FIRST MANUFACTURED

2010

MODEL FORMAT

.BIM / .SAT

SCALE

NOT TO SCALE



FIRST ANGLE PROJECTION

COPY RIGHT YEAR

2019

SIZES

VARIOUS

INDEMANDDRAWINGOFFICE.CO.ZA LINK

CLICK HERE

DRAWING CATEGORY

RENDER STD-CA001



THE CONTENTS OF THIS DRAWING IS THE SOLE PROPERTY OF IN DEMAND TRADING (PTY) LTD
 AND MAY NOT BE COPIED, DIVULGED TO ANY THIRD PARTY WITHOUT THE WRITTEN CONSENT
 In Demand Trading (Pty) Ltd | Reg Number: 2014/057552/07 | VAT Number: 4568746

T// +27 (0)21 791 1888
 SALES@INDEMANDTRADING.CO.ZA
 WWW.INDEMANDTRADING.CO.ZA



PERSPECTIVE VIEW

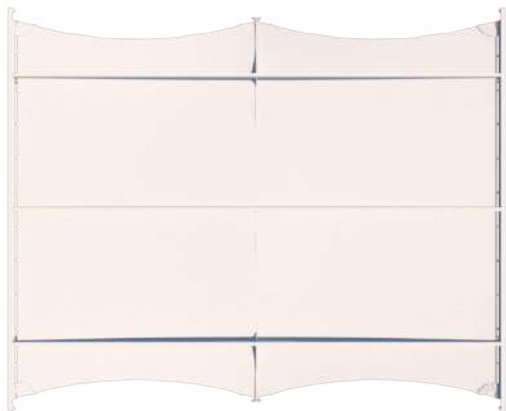

TOP VIEW

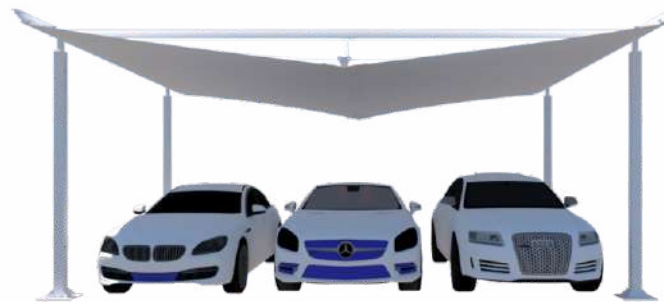

FRONT VIEW



SIDE VIEW

IN DEMAND TRADING (PTY) LTD
 STEPPING STONES GARDEN VILLAGE
 283 OLD HONEYDEW ROAD WEST
 NORTHRIDING, JHB, GAUTENG, RSA



INDEMANDdrawingoffice.co.za
 Download BIM, DWG and 3D model tensile shade structures

DESCRIPTION

CARACAUPORT

CATEGORY
 STANDARD STRUCTURE

CATEGORY
 STANDARD STRUCTURE

MEMBRANE OPTIONS

ARCHITECTURAL PVC AND THERMOFLEX

IMAGE FORMAT

.PNG

SOFTWARE

AUTODESK INVENTOR

YEAR DRAWN

2010

YEAR FIRST MANUFACTURED

2010

MODEL FORMAT

.BIM / .SATT

SCALE

NOT TO SCALE



FIRST ANGLE PROJECTION

COPY RIGHT YEAR

2019

SIZES

VARIOUS



THE CONTENTS OF THIS DRAWING IS THE SOLE PROPERTY OF IN DEMAND TRADING (PTY) LTD
 AND MAY NOT BE COPIED OR DIVULGED TO ANY THIRD PARTY WITHOUT THE WRITTEN CONSENT
 In Demand Trading (Pty) Ltd | Reg Number: 2014/057552/07 | VAT Number: 4568746

T// +27 (0)21 791 1888
 SALES@INDEMANDTRADING.CO.ZA
 WWW.INDEMANDTRADING.CO.ZA



PERSPECTIVE VIEW



TOP VIEW



FRONT VIEW



REAR VIEW

IN DEMAND TRADING (PTY) LTD
 STEPPING STONES GARDEN VILLAGE
 283 OLD HONEYDEW ROAD WEST
 NORTHRIDING, JHB, GAUTENG, RSA



INDEMANDdrawingoffice.co.za
 Download BIM, DWG and 3D model tensile shade structures

DESCRIPTION

SUNLAR STRUCTURE

CATEGORY
 STANDARD STRUCTURE

CATEGORY
 STANDARD STRUCTURE

MEMBRANE OPTIONS:

ARCHITECTURAL PVC, THERMOFLEX AND SHADECLOTH

IMAGE FORMAT

.PNG

SOFTWARE

AUTODESK INVENTOR

YEAR DRAWN

2018

YEAR FIRST MANUFACTURED

2018

COPY RIGHT YEAR

2019

MODEL FORMAT

.BIM / .SAT

SCALE

NOT TO SCALE

SIZES

VARIOUS

INDEMANDDRAWINGOFFICE.CO.ZA LINK

CLICK HERE

DRAWING CATEGORY

RENDER STD-SU001



FIRST ANGLE PROJECTION



THE CONTENTS OF THIS DRAWING IS THE SOLE PROPERTY OF IN DEMAND TRADING (PTY) LTD
 AND MAY NOT BE COPIED OR DIVULGED TO ANY THIRD PARTY WITHOUT THE WRITTEN CONSENT
 In Demand Trading (Pty) Ltd | Reg Number: 2014/057552/07 | VAT Number: 4568746

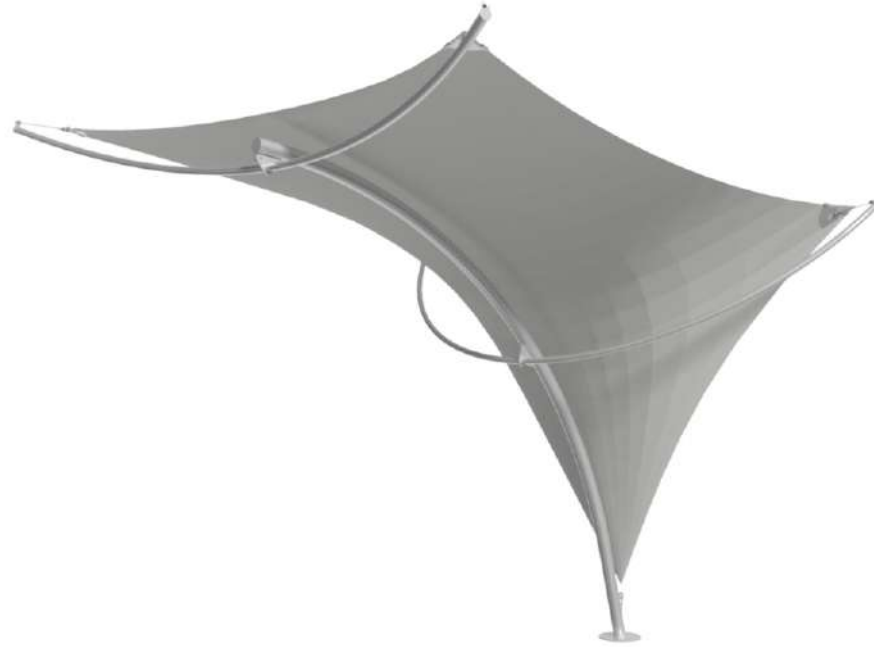

PERSPECTIVE VIEW



TOP VIEW



FRONT VIEW



SIDE VIEW

IN DEMAND TRADING (PTY) LTD
 STEPPING STONES GARDEN VILLAGE
 283 OLD HONEYDEW ROAD WEST
 NORTHRIDING, JHB, GAUTENG, RSA



INDEMANDdrawingoffice.co.za
 Download BIM, DWG and 3D model tensile shade structures

DESCRIPTION

SKY STRUCTURE

CATEGORY
 STANDARD STRUCTURE

CATEGORY
 STANDARD STRUCTURE

MEMBRANE OPTIONS

ARCHITECTURAL PVC, THERMOFLEX AND SHADECLOTH

IMAGE FORMAT

.PNG

SOFTWARE

AUTODESK INVENTOR

YEAR DRAWN

2013

YEAR FIRST MANUFACTURED

2013

COPY RIGHT YEAR

2019

MODEL FORMAT

.BIM / .SATT

SCALE

NOT TO SCALE

SIZES

VARIOUS

INDEMANDDRAWINGOFFICE.CO.ZA LINK

CLICK HERE

DRAWING CATEGORY

RENDER STD-SK001



FIRST ANGLE PROJECTION



THE CONTENTS OF THIS DRAWING IS THE SOLE PROPERTY OF IN DEMAND TRADING (PTY) LTD
 AND MAY NOT BE COPIED, DIVULGED TO ANY THIRD PARTY WITHOUT THE WRITTEN CONSENT
 In Demand Trading (Pty) Ltd | Reg Number: 2014/057552/07 | VAT Number: 4568746



PERSPECTIVE VIEW



TOP VIEW



FRONT VIEW



SIDE VIEW

IN DEMAND TRADING (PTY) LTD
 STEPPING STONES GARDEN VILLAGE
 283 OLD HONEYDEW ROAD WEST
 NORTHRIDING, JHB, GAUTENG, RSA

T// +27 (0)21 791 1888
 SALES@INDEMANDTRADING.CO.ZA
 WWW.INDEMANDTRADING.CO.ZA



INDEMANDdrawingoffice.co.za
 Download BIM, DWG and 3D model tensile shade structures

DESCRIPTION CHANNEL EDGE GUTTERBRELLA MONOPEAK		INDEMANDDRAWINGOFFICE.CO.ZA LINK CLICK HERE	
CATEGORY STANDARD STRUCTURE		DRAWING CATEGORY RENDER STD-GB001	
CATEGORY STANDARD STRUCTURE	IMAGE FORMAT .PNG	SOFTWARE AUTODESK INVENTOR	YEAR DRAWN 2011
MEMBRANE OPTIONS ARCHITECTURAL PVC AND THERMOFLEX		MODEL FORMAT .BIM / .SATT	YEAR FIRST MANUFACTURED 2011
		SCALE NOT TO SCALE	COPY RIGHT YEAR 2019
			SIZES VARIOUS

FIRST ANGLE PROJECTION	
------------------------	--



THE CONTENTS OF THIS DRAWING IS THE SOLE PROPERTY OF IN DEMAND TRADING (PTY) LTD AND MAY NOT BE COPIED, DIVULGED TO ANY THIRD PARTY WITHOUT THE WRITTEN CONSENT
 In Demand Trading (Pty) Ltd | Reg Number: 2014/057552/07 | VAT Number: 4568746



PERSPECTIVE VIEW

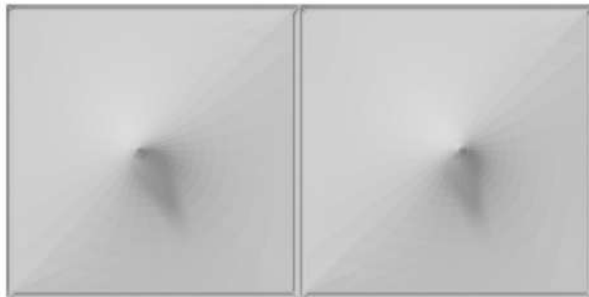

TOP VIEW



FRONT VIEW

SIDE VIEW

IN DEMAND TRADING (PTY) LTD
 STEPPING STONES GARDEN VILLAGE
 283 OLD HONEYDEW ROAD WEST
 NORTHRIDING, JHB, GAUTENG, RSA

T// +27 (0)21 791 1888
 SALES@INDEMANDTRADING.CO.ZA
 WWW.INDEMANDTRADING.CO.ZA



INDEMANDdrawingoffice.co.za
 Download BIM, DWG and 3D model tensile shade structures

DESCRIPTION

CHANNEL EDGE GUTTERBRELLA DUALPEAK

CATEGORY

STANDARD STRUCTURE

CATEGORY

STANDARD STRUCTURE

MEMBRANE OPTIONS

ARCHITECTURAL PVC AND THERMOFLEX

IMAGE FORMAT

.PNG

SOFTWARE

AUTODESK INVENTOR

YEAR DRAWN

2010

YEAR FIRST MANUFACTURED

2010

MODEL FORMAT

.BIM / .SAT

SCALE

NOT TO SCALE

COPY RIGHT YEAR

2019

SIZES

VARIOUS

INDEMANDDRAWINGOFFICE.CO.ZA LINK

CLICK HERE

DRAWING CATEGORY

RENDER STD-GB002

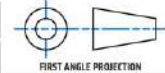

FIRST ANGLE PROJECTION



THE CONTENTS OF THIS DRAWING IS THE SOLE PROPERTY OF IN DEMAND TRADING (PTY) LTD
 AND MAY NOT BE COPIED, OF DIVULGED TO ANY THIRD PARTY WITHOUT THE WRITTEN CONSENT
 In Demand Trading (Pty) Ltd | Reg Number: 2014/057552/07 | VAT Number: 4568746



PERSPECTIVE VIEW



TOP VIEW



FRONT VIEW

SIDE VIEW

IN DEMAND TRADING (PTY) LTD
 STEPPING STONES GARDEN VILLAGE
 283 OLD HONEYDEW ROAD WEST
 NORTHRIDING, JHB, GAUTENG, RSA



INDEMANDdrawingoffice.co.za
 Download BIM, DWG and 3D model tensile shade structures

DESCRIPTION

CHANNEL EDGE GUTTERBRELLA TRIPEAK

CATEGORY
 STANDARD STRUCTURE

CATEGORY
 STANDARD STRUCTURE

MEMBRANE OPTIONS
 ARCHITECTURAL PVC AND THERMOFLEX

IMAGE FORMAT
 .PNG

SOFTWARE
 AUTODESK INVENTOR

YEAR DRAWN
 2010

MODEL FORMAT
 .BIM / .SATT

YEAR FIRST MANUFACTURED
 2010

SCALE
 NOT TO SCALE



FIRST ANGLE PROJECTION

COPY RIGHT YEAR
 2019

SIZES
 VARIOUS

INDEMANDDRAWINGOFFICE.CO.ZA LINK



DRAWING CATEGORY
 RENDER STD-GB003



THE CONTENTS OF THIS DRAWING IS THE SOLE PROPERTY OF IN DEMAND TRADING (PTY) LTD
 AND MAY NOT BE COPIED OR DIVULGED TO ANY THIRD PARTY WITHOUT THE WRITTEN CONSENT
 In Demand Trading (Pty) Ltd | Reg Number: 2014/057552/07 | VAT Number: 4568746



PERSPECTIVE VIEW



TOP VIEW



FRONT VIEW



SIDE VIEW

IN DEMAND TRADING (PTY) LTD
 STEPPING STONES GARDEN VILLAGE
 283 OLD HONEYDEW ROAD WEST
 NORTHRIDING, JHB, GAUTENG, RSA



INDEMANDdrawingoffice.co.za
 Download BIM, DWG and 3D model tensile shade structures

DESCRIPTION

CHANNEL EDGE GUTTERBRELLA MONOPEAK

CATEGORY

STANDARD STRUCTURE

CATEGORY

STANDARD STRUCTURE

MEMBRANE OPTIONS:

ARCHITECTURAL PVC AND THERMOFLEX

IMAGE FORMAT

.PNG

SOFTWARE

AUTODESK INVENTOR

YEAR DRAWN

2011

YEAR FIRST MANUFACTURED

2011

COPY RIGHT YEAR

2019

MODEL FORMAT

.BIM / .SAT

SCALE

NOT TO SCALE

SIZES

VARIOUS

INDEMANDDRAWINGOFFICE.CO.ZA LINK

CLICK HERE

DRAWING CATEGORY

RENDER STD-GB001



FIRST ANGLE PROJECTION



THE CONTENTS OF THIS DRAWING IS THE SOLE PROPERTY OF IN DEMAND TRADING (PTY) LTD
 AND MAY NOT BE COPIED, DIVULGED TO ANY THIRD PARTY WITHOUT THE WRITTEN CONSENT
 In Demand Trading (Pty) Ltd | Reg Number: 2014/057552/07 | VAT Number: 4568746



PERSPECTIVE VIEW



TOP VIEW



FRONT VIEW



SIDE VIEW

IN DEMAND TRADING (PTY) LTD
 STEPPING STONES GARDEN VILLAGE
 283 OLD HONEYDEW ROAD WEST
 NORTHRIDING, JHB, GAUTENG, RSA

T// +27 (0)21 791 1888
 SALES@INDEMANDTRADING.CO.ZA
 WWW.INDEMANDTRADING.CO.ZA



INDEMANDdrawingoffice.co.za
 Download BIM, DWG and 3D model tensile shade structures

DESCRIPTION

CHANNEL EDGE DUALPEAK

CATEGORY

STANDARD STRUCTURE

CATEGORY

STANDARD STRUCTURE

MEMBRANE OPTIONS:

ARCHITECTURAL PVC AND THERMOFLEX

IMAGE FORMAT

.PNG

SOFTWARE

AUTODESK INVENTOR

YEAR DRAWN

2011

YEAR FIRST MANUFACTURED

2011

COPY RIGHT YEAR

2019

MODEL FORMAT

.BIM / .SATT

SCALE

NOT TO SCALE

SIZES

VARIOUS

INDEMANDDRAWINGOFFICE.CO.ZA LINK

CLICK HERE

DRAWING CATEGORY

RENDER STD-CE002



FIRST ANGLE PROJECTION



THE CONTENTS OF THIS DRAWING IS THE SOLE PROPERTY OF IN DEMAND TRADING (PTY) LTD
 AND MAY NOT BE COPIED OR DIVULGED TO ANY THIRD PARTY WITHOUT THE WRITTEN CONSENT
 In Demand Trading (Pty) Ltd | Reg Number: 2014/057552/07 | VAT Number: 4568746



PERSPECTIVE VIEW

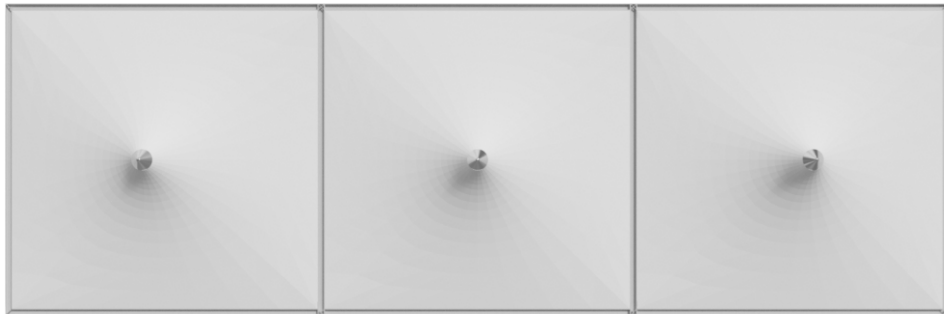

TOP VIEW



FRONT VIEW

IN DEMAND TRADING (PTY) LTD
 STEPPING STONES GARDEN VILLAGE
 283 OLD HONEYDEW ROAD WEST
 NORTHRIDING, JHB, GAUTENG, RSA

T// +27 (0)21 791 1888
 SALES@INDEMANDTRADING.CO.ZA
 WWW.INDEMANDTRADING.CO.ZA



INDEMANDdrawingoffice.co.za
 Download BIM, DWG and 3D model tensile shade structures

DESCRIPTION

CHANNEL EDGE TRIPEAK

CATEGORY

STANDARD STRUCTURE

CATEGORY

STANDARD STRUCTURE

MEMBRANE OPTIONS

ARCHITECTURAL PVC AND THERMOFLEX

IMAGE FORMAT

.PNG

SOFTWARE

AUTODESK INVENTOR

YEAR DRAWN

2011

YEAR FIRST MANUFACTURED

2011

COPY RIGHT YEAR

2019

MODEL FORMAT

.BIM / .SATT

SCALE

NOT TO SCALE

SIZES

VARIOUS

INDEMANDDRAWINGOFFICE.CO.ZA LINK

CLICK HERE

DRAWING CATEGORY

RENDER STD-CE003



FIRST ANGLE PROJECTION



THE CONTENTS OF THIS DRAWING IS THE SOLE PROPERTY OF IN DEMAND TRADING (PTY) LTD AND MAY NOT BE COPIED, DIVULGED TO ANY THIRD PARTY WITHOUT THE WRITTEN CONSENT
 In Demand Trading (Pty) Ltd | Reg Number: 2014/057552/07 | VAT Number: 4568746



PERSPECTIVE VIEW



TOP VIEW



FRONT VIEW



SIDE VIEW

IN DEMAND TRADING (PTY) LTD
 STEPPING STONES GARDEN VILLAGE
 283 OLD HONEYDEW ROAD WEST
 NORTHRIDING, JHB, GAUTENG, RSA



INDEMANDdrawingoffice.co.za
 Download BIM, DWG and 3D model tensile shade structures

DESCRIPTION

MONO PEAK OUTRIGGER

CATEGORY

STANDARD STRUCTURE - OUTRIGGER ARMS

CATEGORY

STANDARD STRUCTURE

IMAGE FORMAT

.PNG

SOFTWARE

AUTODESK INVENTOR

YEAR DRAWN

2012

YEAR FIRST MANUFACTURED

2012

COPY RIGHT YEAR

2019

MEMBRANE OPTIONS

ARCHITECTURAL PVC AND THERMOFLEX

MODEL FORMAT

.BIM / .SAT

SCALE

NOT TO SCALE

SIZES

VARIOUS

INDEMANDDRAWINGOFFICE.CO.ZA LINK

CLICK HERE

DRAWING CATEGORY

RENDER STD-OU001

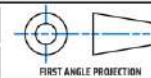

FIRST ANGLE PROJECTION



THE CONTENTS OF THIS DRAWING IS THE SOLE PROPERTY OF IN DEMAND TRADING (PTY) LTD
 AND MAY NOT BE COPIED, DIVULGED TO ANY THIRD PARTY WITHOUT THE WRITTEN CONSENT
 In Demand Trading (Pty) Ltd | Reg Number: 2014/057552/07 | VAT Number: 4568746



FRONT VIEW



TOP VIEW



SIDE VIEW

IN DEMAND TRADING (PTY) LTD
 STEPPING STONES GARDEN VILLAGE
 283 OLD HONEYDEW ROAD WEST
 NORTHRIDING, JHB, GAUTENG, RSA

T// +27 (0)21 791 1888
 SALES@INDEMANDTRADING.CO.ZA
 WWW.INDEMANDTRADING.CO.ZA



INDEMANDdrawingoffice.co.za
 Download BIM, DWG and 3D model tensile shade structures

DESCRIPTION

DUAL PEAK OUTRIGGER

CATEGORY
 STANDARD STRUCTURE - OUTRIGGER ARMS

CATEGORY
 STANDARD STRUCTURE

MEMBRANE OPTIONS
 ARCHITECTURAL PVC, THERMOFLEX AND SHADECLOTH

INDEMANDDRAWINGOFFICE.CO.ZA LINK



DRAWING CATEGORY

RENDER STD-OU001

SOFTWARE
 AUTODESK INVENTOR

MODEL FORMAT
 .BIM / .SAT

YEAR DRAWN
 2015

YEAR FIRST MANUFACTURED
 2015

SCALE
 NOT TO SCALE

SIZES
 VARIOUS

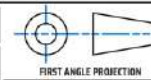

FIRST ANGLE PROJECTION



THE CONTENTS OF THIS DRAWING IS THE SOLE PROPERTY OF IN DEMAND TRADING (PTY) LTD AND MAY NOT BE COPIED OR DIVULGED TO ANY THIRD PARTY WITHOUT THE WRITTEN CONSENT
 In Demand Trading (Pty) Ltd | Reg Number: 2014/057552/07 | VAT Number: 4568746



PERSPECTIVE VIEW



TOP VIEW



FRONT VIEW



SIDE VIEW

IN DEMAND TRADING (PTY) LTD
 STEPPING STONES GARDEN VILLAGE
 283 OLD HONEYDEW ROAD WEST
 NORTHRIDING, JHB, GAUTENG, RSA



INDEMANDdrawingoffice.co.za
 Download BIM, DWG and 3D model tensile shade structures

DESCRIPTION

TRI PEAK OUTRIGGER

CATEGORY
 STANDARD STRUCTURE - OUTRIGGER ARMS WALL MOUNTED

CATEGORY
 STANDARD STRUCTURE IMAGE FORMAT .PNG SOFTWARE AUTODESK INVENTOR

MEMBRANE OPTIONS
 ARCHITECTURAL PVC, THERMOFLEX AND SHADECLOTH

INDEMANDDRAWINGOFFICE.CO.ZA LINK

CLICK HERE
 DRAWING CATEGORY
 RENDER STD-OU003

YEAR DRAWN 2015 YEAR FIRST MANUFACTURED 2015

MODEL FORMAT .BIM / .SATT SCALE NOT TO SCALE



FIRST ANGLE PROJECTION

COPY RIGHT YEAR 2019

SIZES VARIOUS



THE CONTENTS OF THIS DRAWING IS THE SOLE PROPERTY OF IN DEMAND TRADING (PTY) LTD AND MAY NOT BE COPIED OR DIVULGED TO ANY THIRD PARTY WITHOUT THE WRITTEN CONSENT
 In Demand Trading (Pty) Ltd | Reg Number: 2014/057552/07 | VAT Number: 4568746



PERSPECTIVE VIEW

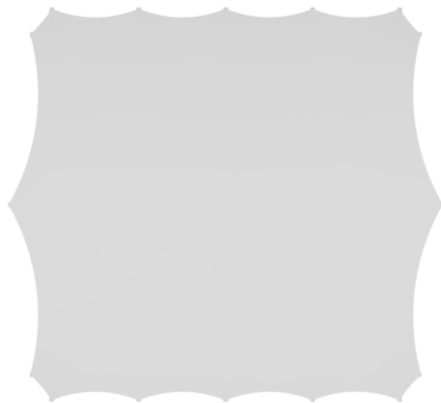

TOP VIEW

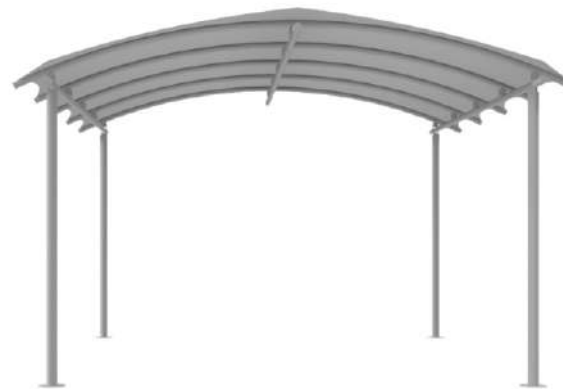

FRONT VIEW



SIDE VIEW

IN DEMAND TRADING (PTY) LTD
 STEPPING STONES GARDEN VILLAGE
 283 OLD HONEYDEW ROAD WEST
 NORTHRIDING, JHB, GAUTENG, RSA



INDEMANDdrawingoffice.co.za
 Download BIM, DWG and 3D model tensile shade structures

DESCRIPTION

RAMPANT ARCH STAND ALONE

CATEGORY

STANDARD STRUCTURE - RAMPANT ARCH

CATEGORY

STANDARD STRUCTURE

IMAGE FORMAT

.PNG

SOFTWARE

AUTODESK INVENTOR

MEMBRANE OPTIONS

ARCHITECTURAL PVC AND THERMOFLEX

INDEMANDDRAWINGOFFICE.CO.ZA LINK

[CLICK HERE](#)

DRAWING CATEGORY

RENDER STD-RA001

YEAR DRAWN

2012

YEAR FIRST MANUFACTURED

2012

MODEL FORMAT

.BIM / .SAT

SCALE

NOT TO SCALE



FIRST ANGLE PROJECTION

COPY RIGHT YEAR

2019

SIZES

VARIOUS



THE CONTENTS OF THIS DRAWING IS THE SOLE PROPERTY OF IN DEMAND TRADING (PTY) LTD
 AND MAY NOT BE COPIED OR DIVULGED TO ANY THIRD PARTY WITHOUT THE WRITTEN CONSENT
 In Demand Trading (Pty) Ltd | Reg Number: 2014/057552/07 | VAT Number: 4568746

T: // +27 (0)21 791 1888
 SALES@INDEMANDTRADING.CO.ZA
 WWW.INDEMANDTRADING.CO.ZA



PERSPECTIVE VIEW

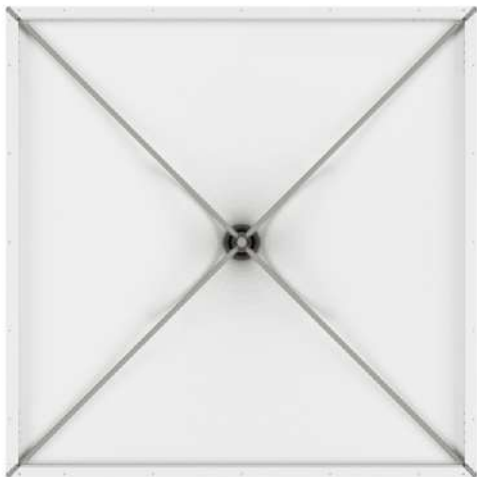

TOP VIEW



FRONT VIEW



SIDE VIEW

IN DEMAND TRADING (PTY) LTD
 STEPPING STONES GARDEN VILLAGE
 283 OLD HONEYDEW ROAD WEST
 NORTHRIDING, JHB, GAUTENG, RSA



INDEMANDdrawingoffice.co.za
 Download BIM, DWG and 3D model tensile shade structures

DESCRIPTION

TULIP TENSILE STRUCTURE

CATEGORY
 STANDARD STRUCTURE

CATEGORY
 STANDARD STRUCTURE

MEMBRANE OPTIONS
 ARCHITECTURAL PVC

IMAGE FORMAT

.PNG

SOFTWARE

AUTODESK INVENTOR

YEAR DRAWN

2011

YEAR FIRST MANUFACTURED

2011

COPY RIGHT YEAR

2019

MODEL FORMAT
 .BIM / .SATT

SCALE
 NOT TO SCALE

SIZES
 VARIOUS

INDEMANDDRAWINGOFFICE.CO.ZA LINK

CLICK HERE

DRAWING CATEGORY

RENDER STD-TU001



FIRST ANGLE PROJECTION



THE CONTENTS OF THIS DRAWING IS THE SOLE PROPERTY OF IN DEMAND TRADING (PTY) LTD AND MAY NOT BE COPIED OR DIVULGED TO ANY THIRD PARTY WITHOUT THE WRITTEN CONSENT
 In Demand Trading (Pty) Ltd | Reg Number: 2014/057552/07 | VAT Number: 4568746



PERSPECTIVE VIEW

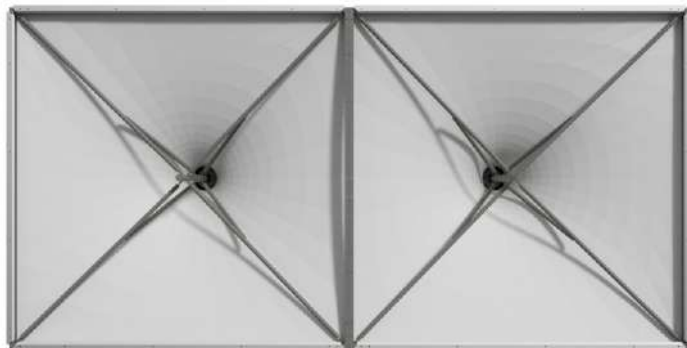

TOP VIEW



FRONT VIEW



SIDE VIEW

IN DEMAND TRADING (PTY) LTD
 STEPPING STONES GARDEN VILLAGE
 283 OLD HONEYDEW ROAD WEST
 NORTHRIDING, JHB, GAUTENG, RSA
 T// +27 (0)21 791 1888
 SALES@INDEMANDTRADING.CO.ZA
 WWW.INDEMANDTRADING.CO.ZA



INDEMANDdrawingoffice.co.za
 Download BIM, DWG and 3D model tensile shade structures

DESCRIPTION DUAL TULIP TENSILE STRUCTURE		INDEMANDDRAWINGOFFICE.CO.ZA LINK CLICK HERE	
CATEGORY STANDARD STRUCTURE		DRAWING CATEGORY RENDER STD-TU002	
CATEGORY STANDARD STRUCTURE	IMAGE FORMAT .PNG	SOFTWARE AUTODESK INVENTOR	YEAR DRAWN 2011
MEMBRANE OPTIONS ARCHITECTURAL PVC		MODEL FORMAT .BIM / .SATT	YEAR FIRST MANUFACTURED 2011
		SCALE NOT TO SCALE	COPY RIGHT YEAR 2019
			SIZES VARIOUS

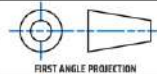

THE CONTENTS OF THIS DRAWING IS THE SOLE PROPERTY OF IN DEMAND TRADING (PTY) LTD AND MAY NOT BE COPIED, DIVULGED TO ANY THIRD PARTY WITHOUT THE WRITTEN CONSENT
 In Demand Trading (Pty) Ltd | Reg Number: 2014/057552/07 | VAT Number: 4568746



PERSPECTIVE VIEW

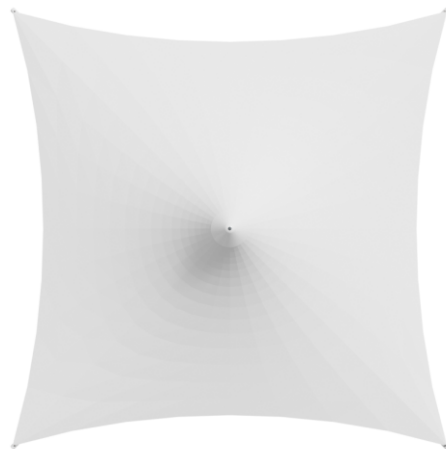

TOP VIEW



FRONT VIEW

IN DEMAND TRADING (PTY) LTD
 STEPPING STONES GARDEN VILLAGE
 283 OLD HONEYDEW ROAD WEST
 NORTHRIDING, JHB, GAUTENG, RSA



INDEMANDdrawingoffice.co.za
 Download BIM, DWG and 3D model tensile shade structures

DESCRIPTION

CABANA GROUND LEVEL

CATEGORY
 STANDARD STRUCTURE

CATEGORY
 STANDARD STRUCTURE

MEMBRANE OPTIONS

ARCHITECTURAL PVC, THERMOFLEX AND SHADECLOTH

IMAGE FORMAT
 .PNG

SOFTWARE
 AUTODESK INVENTOR

YEAR DRAWN
 2014

MODEL FORMAT
 .BIM / .SATT

YEAR FIRST MANUFACTURED
 2014

SCALE
 NOT TO SCALE



FIRST ANGLE PROJECTION

COPY RIGHT YEAR
 2019

SIZES
 5.0 X 5.0M

INDEMANDDRAWINGOFFICE.CO.ZA LINK

CLICK HERE

DRAWING CATEGORY
 RENDER STD-CA001



THE CONTENTS OF THIS DRAWING IS THE SOLE PROPERTY OF IN DEMAND TRADING (PTY) LTD AND MAY NOT BE COPIED OR DIVULGED TO ANY THIRD PARTY WITHOUT THE WRITTEN CONSENT
 In Demand Trading (Pty) Ltd | Reg Number: 2014/057552/07 | VAT Number: 4568746



FRONT VIEW



TOP VIEW



PERSPECTIVE VIEW

IN DEMAND TRADING (PTY) LTD
 STEPPING STONES GARDEN VILLAGE
 283 OLD HONEYDEW ROAD WEST
 NORTHRIDING, JHB, GAUTENG, RSA

T// +27 (0)21 791 1888
 SALES@INDEMANDTRADING.CO.ZA
 WWW.INDEMANDTRADING.CO.ZA



INDEMANDdrawingoffice.co.za
 Download BIM, DWG and 3D model tensile shade structures

DESCRIPTION

CABANA GROUND RAISED

CATEGORY

STANDARD STRUCTURE

CATEGORY

STANDARD STRUCTURE

MEMBRANE OPTIONS

ARCHITECTURAL PVC, THERMOFLEX AND SHADECLOTH

IMAGE FORMAT

.PNG

SOFTWARE

AUTODESK INVENTOR

YEAR DRAWN

2014

YEAR FIRST MANUFACTURED

2014

MODEL FORMAT

.BIM / .SATT

SCALE

NOT TO SCALE

COPY RIGHT YEAR

2019

SIZES

5.0 X 5.0M

INDEMANDDRAWINGOFFICE.CO.ZA LINK

CLICK HERE

DRAWING CATEGORY

RENDER STD-CA002

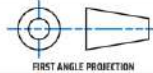

FIRST ANGLE PROJECTION



THE CONTENTS OF THIS DRAWING IS THE SOLE PROPERTY OF IN DEMAND TRADING (PTY) LTD AND MAY NOT BE COPIED OR DIVULGED TO ANY THIRD PARTY WITHOUT THE WRITTEN CONSENT
 In Demand Trading (Pty) Ltd | Reg Number: 2014/057552/07 | VAT Number: 4568746



PERSPECTIVE VIEW

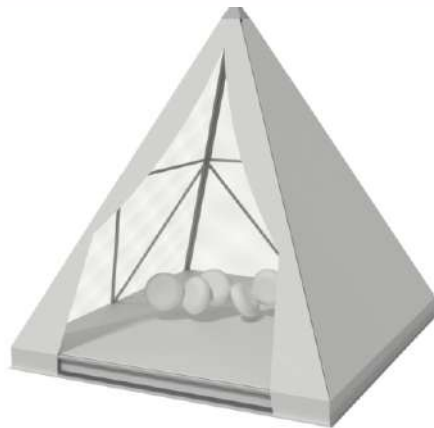

ISO VIEW

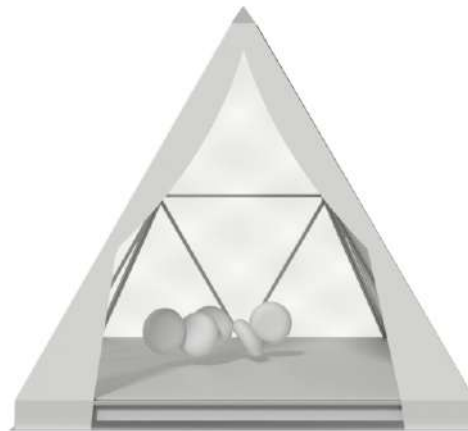

FRONT VIEW



ISO VIEW

IN DEMAND TRADING (PTY) LTD
 STEPPING STONES GARDEN VILLAGE
 283 OLD HONEYDEW ROAD WEST
 NORTHRIDING, JHB, GAUTENG, RSA



INDEMANDdrawingoffice.co.za
 Download BIM, DWG and 3D model tensile shade structures

DESCRIPTION

PYRAMID DAY BED

CATEGORY
 STANDARD STRUCTURE

CATEGORY
 STANDARD STRUCTURE

MEMBRANE OPTIONS

ARCHITECTURAL PVC AND THERMOFLEX

IMAGE FORMAT

.PNG

SOFTWARE

AUTODESK INVENTOR

YEAR DRAWN

2014

YEAR FIRST MANUFACTURED

2014

COPY RIGHT YEAR

2019

MODEL FORMAT

.BIM / .SAT

SCALE

NOT TO SCALE

SIZES

2.5M X 2.5M

INDEMANDDRAWINGOFFICE.CO.ZA LINK

CLICK HERE

DRAWING CATEGORY

RENDER STD-DB001



FIRST ANGLE PROJECTION



THE CONTENTS OF THIS DRAWING IS THE SOLE PROPERTY OF IN DEMAND TRADING (PTY) LTD
 AND MAY NOT BE COPIED OR DIVULGED TO ANY THIRD PARTY WITHOUT THE WRITTEN CONSENT
 In Demand Trading (Pty) Ltd | Reg Number: 2014/057552/07 | VAT Number: 4568746



PERSPECTIVE VIEW



TOP VIEW



FRONT VIEW

IN DEMAND TRADING (PTY) LTD
 STEPPING STONES GARDEN VILLAGE
 283 OLD HONEYDEW ROAD WEST
 NORTHRIDING, JHB, GAUTENG, RSA

T: // +27 (0)21 791 1888
 SALES@INDEMANDTRADING.CO.ZA
 WWW.INDEMANDTRADING.CO.ZA



INDEMANDdrawingoffice.co.za
 Download BIM, DWG and 3D model tensile shade structures

DESCRIPTION

DECAPORT 10 000 X 10 000MM

CATEGORY

STANDARD STRUCTURE

CATEGORY

STANDARD STRUCTURE

MEMBRANE OPTIONS

SHADECLOTH

IMAGE FORMAT

.PNG

SOFTWARE

AUTODESK INVENTOR

YEAR DRAWN

2009

YEAR FIRST MANUFACTURED

2009

COPY RIGHT YEAR

2019

MODEL FORMAT

.BIM / .SATT

SCALE

NOT TO SCALE

SIZES

10 X 10M

INDEMANDDRAWINGOFFICE.CO.ZA LINK

CLICK HERE

DRAWING CATEGORY

RENDER STD-DE001



FIRST ANGLE PROJECTION



THE CONTENTS OF THIS DRAWING IS THE SOLE PROPERTY OF IN DEMAND TRADING (PTY) LTD
 AND MAY NOT BE COPIED, OF DIVULGED TO ANY THIRD PARTY WITHOUT THE WRITTEN CONSENT
 In Demand Trading (Pty) Ltd | Reg Number: 2014/057552/07 | VAT Number: 4568746

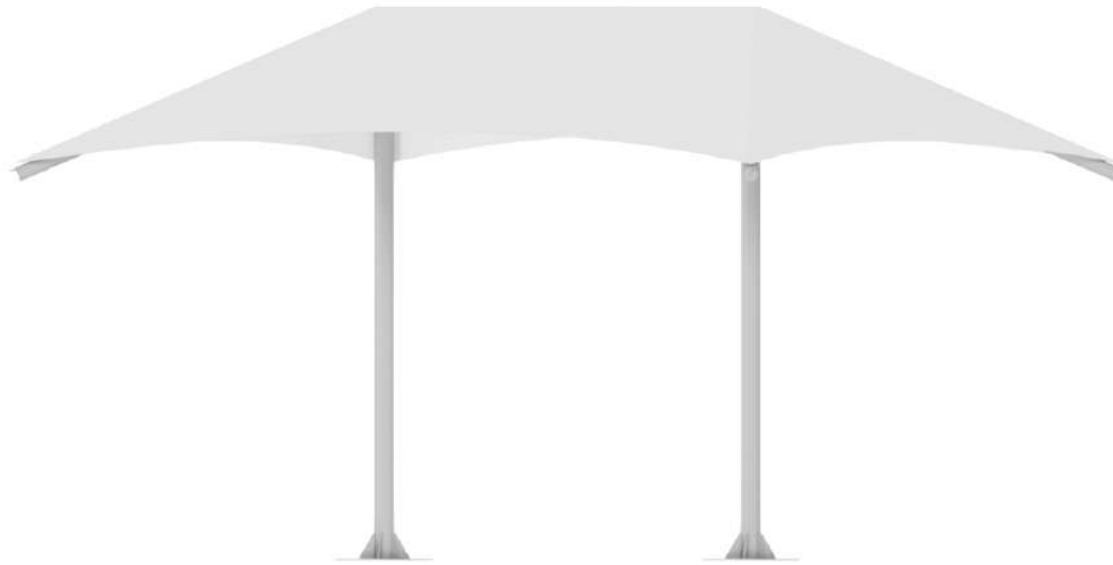

PERSPECTIVE VIEW



TOP VIEW

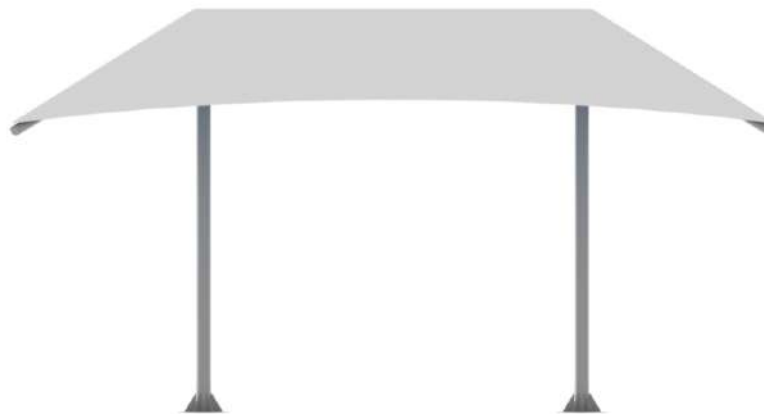

FRONT VIEW



SIDE VIEW

IN DEMAND TRADING (PTY) LTD
 STEPPING STONES GARDEN VILLAGE
 283 OLD HONEYDEW ROAD WEST
 NORTHRIDING, JHB, GAUTENG, RSA



INDEMANDdrawingoffice.co.za
 Download BIM, DWG and 3D model tensile shade structures

T// +27 (0)21 791 1888
 SALES@INDEMANDTRADING.CO.ZA
 WWW.INDEMANDTRADING.CO.ZA

DESCRIPTION

POOLPORT 3 000 X 6 000MM

CATEGORY
 STANDARD STRUCTURE

CATEGORY
 STANDARD STRUCTURE

MEMBRANE OPTIONS
 SHADECLOTH

IMAGE FORMAT
 .PNG

SOFTWARE
 AUTODESK INVENTOR

YEAR DRAWN
 2009

MODEL FORMAT
 .BIM / .SATT

YEAR FIRST MANUFACTURED
 2009

SCALE
 NOT TO SCALE



COPY RIGHT YEAR
 2019

SIZES
 VARIOUS

INDEMANDDRAWINGOFFICE.CO.ZA LINK



DRAWING CATEGORY
 RENDER STD-PO001



THE CONTENTS OF THIS DRAWING IS THE SOLE PROPERTY OF IN DEMAND TRADING (PTY) LTD
 AND MAY NOT BE COPIED OF DIVULGED TO ANY THIRD PARTY WITHOUT THE WRITTEN CONSENT
 In Demand Trading (Pty) Ltd | Reg Number: 2014/057552/07 | VAT Number: 4568746

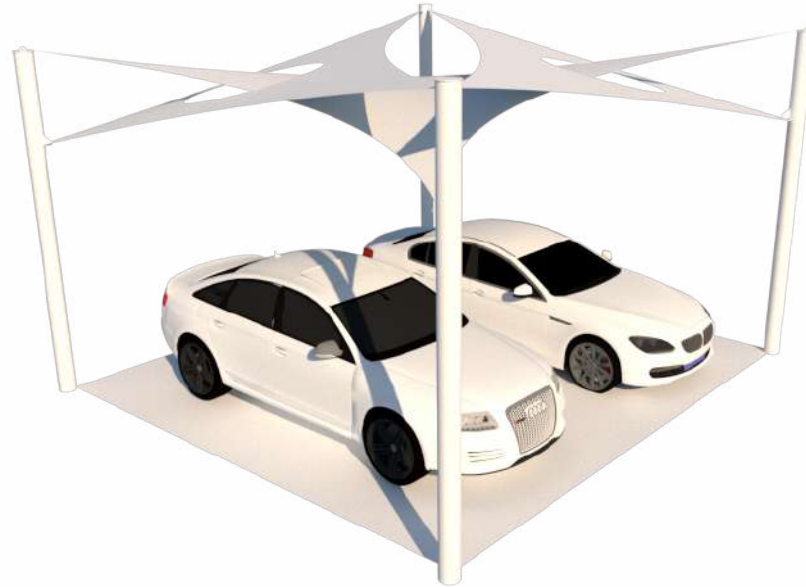

PERSPECTIVE



TOP VIEW

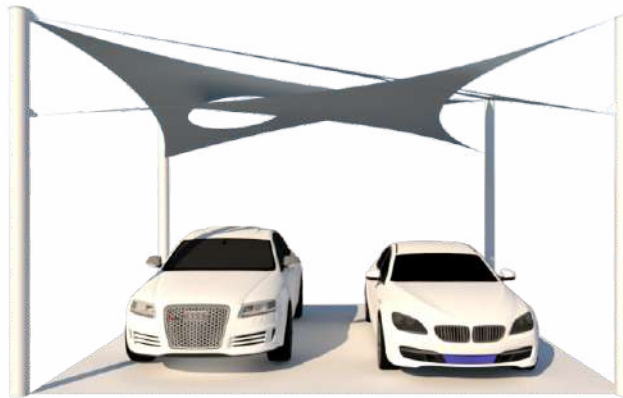

FRONT VIEW

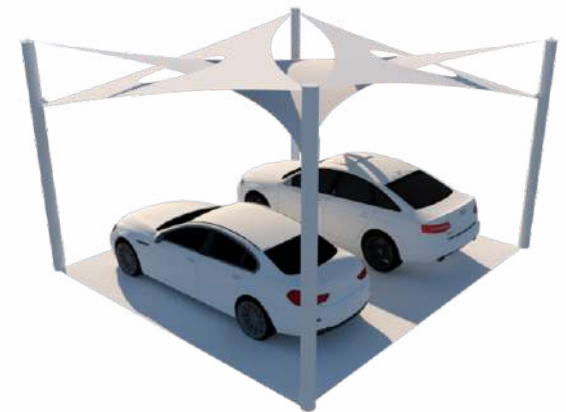

SIDE VIEW

IN DEMAND TRADING (PTY) LTD
 STEPPING STONES GARDEN VILLAGE
 283 OLD HONEYDEW ROAD WEST
 NORTHRIDING, JHB, GAUTENG, RSA



INDEMANDdrawingoffice.co.za
 Download BIM, DWG and 3D model tensile shade structures

DESCRIPTION

HYPARPORT MULTISAIL

CATEGORY
 STANDARD STRUCTURE

CATEGORY
 STANDARD STRUCTURE

MEMBRANE OPTIONS:

ARCHITECTURAL PVC, THERMOFLEX, SHADECLOTH

IMAGE FORMAT

.PNG

SOFTWARE

AUTODESK INVENTOR

YEAR DRAWN

2020

YEAR FIRST MANUFACTURED

2020

MODEL FORMAT

.BIM / .SAT

SCALE

NOT TO SCALE

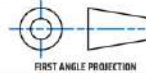

FIRST ANGLE PROJECTION

COPY RIGHT YEAR

2016

SIZES

VARIOUS

INDEMANDDRAWINGOFFICE.CO.ZA LINK

CLICK HERE

DRAWING CATEGORY

RENDER STD-HP001



THE CONTENTS OF THIS DRAWING IS THE SOLE PROPERTY OF IN DEMAND TRADING (PTY) LTD AND MAY NOT BE COPIED, DIVULGED TO ANY THIRD PARTY WITHOUT THE WRITTEN CONSENT
 In Demand Trading (Pty) Ltd | Reg Number: 2014/057552/07 | VAT Number: 4568746

T: // +27 (0)21 791 1888
 SALES@INDEMANDTRADING.CO.ZA
 WWW.INDEMANDTRADING.CO.ZA

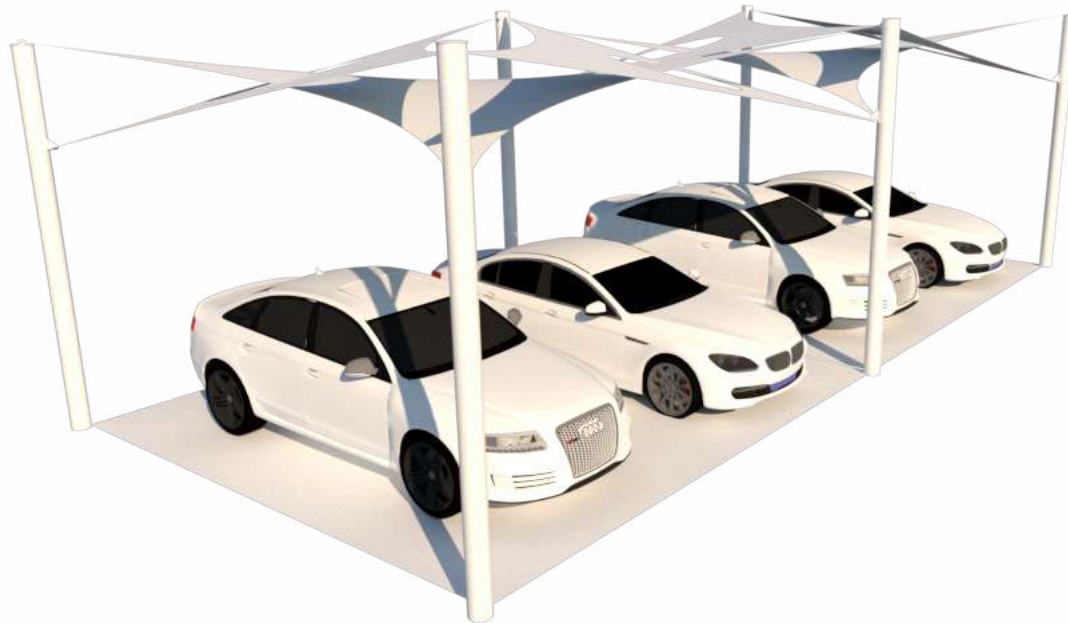

PERSPECTIVE

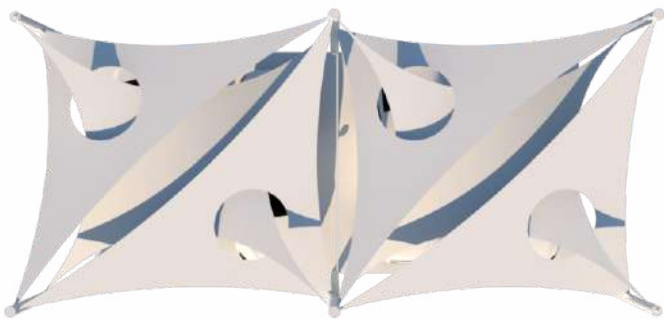

TOP VIEW



FRONT VIEW



SIDE VIEW

IN DEMAND TRADING (PTY) LTD
 STEPPING STONES GARDEN VILLAGE
 283 OLD HONEYDEW ROAD WEST
 NORTHRIDING, JHB, GAUTENG, RSA

T// +27 (0)21 791 1888
 SALES@INDEMANDTRADING.CO.ZA
 WWW.INDEMANDTRADING.CO.ZA



INDEMANDdrawingoffice.co.za
 Download BIM, DWG and 3D model tensile shade structures

DESCRIPTION

HYPARPORT MULTISAIL

CATEGORY

STANDARD STRUCTURE

CATEGORY

STANDARD STRUCTURE

MEMBRANE OPTIONS:

ARCHITECTURAL PVC, THERMOFLEX, SHADECLOTH

IMAGE FORMAT

.PNG

SOFTWARE

AUTODESK INVENTOR

YEAR DRAWN

2020

MODEL FORMAT

.BIM / .SAT

YEAR FIRST MANUFACTURED

2020

SCALE

NOT TO SCALE

COPY RIGHT YEAR

2016

SIZES

VARIOUS

INDEMANDDRAWINGOFFICE.CO.ZA LINK

CLICK HERE

DRAWING CATEGORY

RENDER STD-HP001

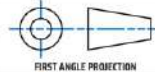

FIRST ANGLE PROJECTION



THE CONTENTS OF THIS DRAWING IS THE SOLE PROPERTY OF IN DEMAND TRADING (PTY) LTD AND MAY NOT BE COPIED OR DIVULGED TO ANY THIRD PARTY WITHOUT THE WRITTEN CONSENT
 In Demand Trading (Pty) Ltd | Reg Number: 2014/057552/07 | VAT Number: 4568746



PERSPECTIVE VIEW



TOP VIEW



FRONT VIEW



SIDE VIEW

IN DEMAND TRADING (PTY) LTD
 STEPPING STONES GARDEN VILLAGE
 283 OLD HONEYDEW ROAD WEST
 NORTHRIDING, JHB, GAUTENG, RSA

T// +27 (0)21 791 1888
 SALES@INDEMANDTRADING.CO.ZA
 WWW.INDEMANDTRADING.CO.ZA



INDEMANDdrawingoffice.co.za
 Download BIM, DWG and 3D model tensile shade structures

DESCRIPTION CARPORT TENSILE STRUCTURE 10 000 X 10 000MM				INDEMANDDRAWINGOFFICE.CO.ZA LINK CLICK HERE	
CATEGORY STANDARD STRUCTURE				DRAWING CATEGORY RENDER STD-CA002	
CATEGORY STANDARD STRUCTURE	IMAGE FORMAT .PNG	SOFTWARE AUTODESK INVENTOR	YEAR DRAWN 2009	YEAR FIRST MANUFACTURED 2009	COPY RIGHT YEAR 2019
MEMBRANE OPTIONS ARCHITECTURAL PVC, THERMOFLEX AND SHADECLOTH			MODEL FORMAT .BIM / .SAT	SCALE NOT TO SCALE	SIZES VARIOUS

FIRST ANGLE PROJECTION	
------------------------	--



THE CONTENTS OF THIS DRAWING IS THE SOLE PROPERTY OF IN DEMAND TRADING (PTY) LTD AND MAY NOT BE COPIED OR DIVULGED TO ANY THIRD PARTY WITHOUT THE WRITTEN CONSENT
 In Demand Trading (Pty) Ltd | Reg Number: 2014/057552/07 | VAT Number: 4568746



PERSPECTIVE VIEW



TOP VIEW



FRONT VIEW



SIDE VIEW

IN DEMAND TRADING (PTY) LTD
 STEPPING STONES GARDEN VILLAGE
 283 OLD HONEYDEW ROAD WEST
 NORTHRIDING, JHB, GAUTENG, RSA



INDEMANDdrawingoffice.co.za
 Download BIM, DWG and 3D model tensile shade structures

DESCRIPTION
 CARPORT TENSILE STRUCTURE 18 000 X 5 000MM

CATEGORY
 STANDARD STRUCTURE

CATEGORY
 STANDARD STRUCTURE

MEMBRANE OPTIONS:

ARCHITECTURAL PVC, THERMOFLEX AND SHADECLOTH

IMAGE FORMAT

.PNG

SOFTWARE

AUTODESK INVENTOR

YEAR DRAWN

2009

YEAR FIRST MANUFACTURED

2009

MODEL FORMAT

.BIM / .SAT

SCALE

NOT TO SCALE

COPY RIGHT YEAR

2019

SIZES

VARIOUS

INDEMANDDRAWINGOFFICE.CO.ZA LINK



DRAWING CATEGORY

RENDER STD-CA003



FIRST ANGLE PROJECTION



THE CONTENTS OF THIS DRAWING IS THE SOLE PROPERTY OF IN DEMAND TRADING (PTY) LTD AND MAY NOT BE COPIED OR DIVULGED TO ANY THIRD PARTY WITHOUT THE WRITTEN CONSENT
 In Demand Trading (Pty) Ltd | Reg Number: 2014/057552/07 | VAT Number: 4568746

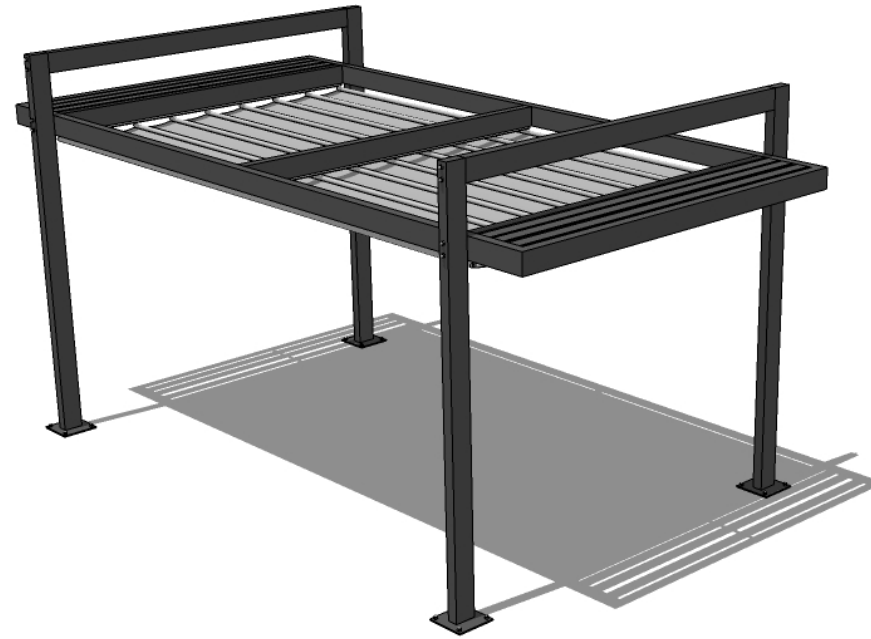

PERSEPTIVE VIEW



TOP VIEW

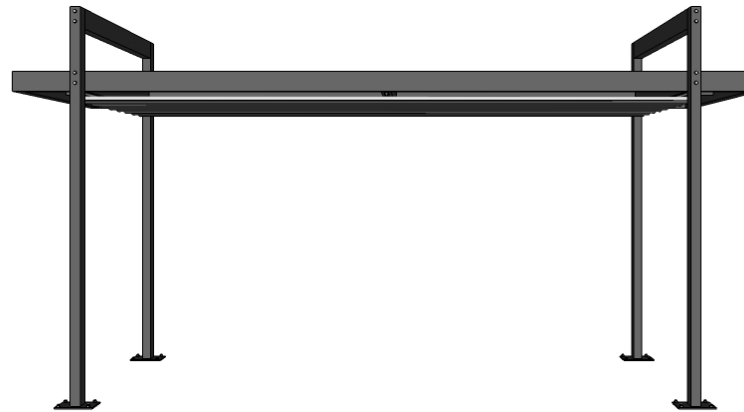

FRONT VIEW

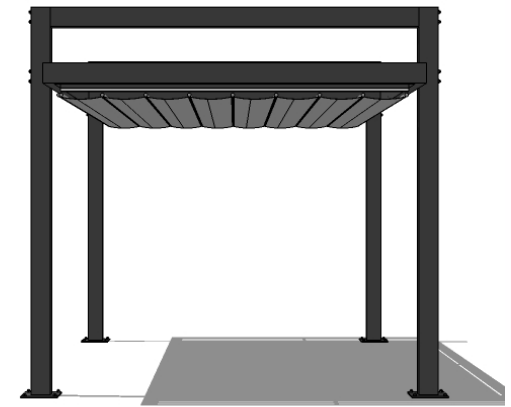

SIDE VIEW

IN DEMAND TRADING (PTY) LTD
 STEPPING STONES GARDEN VILLAGE
 283 OLD HONEYDEW ROAD WEST
 NORTHRIDING, JHB, GAUTENG, RSA

T// +27 (0)21 791 1888
 SALES@INDEMANDTRADING.CO.ZA
 WWW.INDEMANDTRADING.CO.ZA



INDEMANDdrawingoffice.co.za
 Download BIM, DWG and 3D model tensile shade structures

DESCRIPTION

MANUAL RETRACTABLE PERGOLA

CATEGORY
 STANDARD STRUCTURE

CATEGORY
 STANDARD STRUCTURE

MEMBRANE OPTIONS:

ARCHITECTURAL PVC, PROOF AND SHADECLOTH

IMAGE FORMAT

.PNG

SOFTWARE

AUTODESK INVENTOR

YEAR DRAWN

2018

YEAR FIRST MANUFACTURED

2018

MODEL FORMAT

.BIM / .SAT

SCALE

NOT TO SCALE

COPY RIGHT YEAR

2019

SIZES

VARIOUS

INDEMANDDRAWINGOFFICE.CO.ZA LINK

CLICK HERE

DRAWING CATEGORY

RENDER STD-MP002

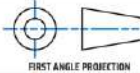

FIRST ANGLE PROJECTION



THE CONTENTS OF THIS DRAWING IS THE SOLE PROPERTY OF IN DEMAND TRADING (PTY) LTD
 AND MAY NOT BE COPIED, DIVULGED TO ANY THIRD PARTY WITHOUT THE WRITTEN CONSENT
 In Demand Trading (Pty) Ltd | Reg Number: 2014/057552/07 | VAT Number: 4568746



PERSEPTIVE VIEW

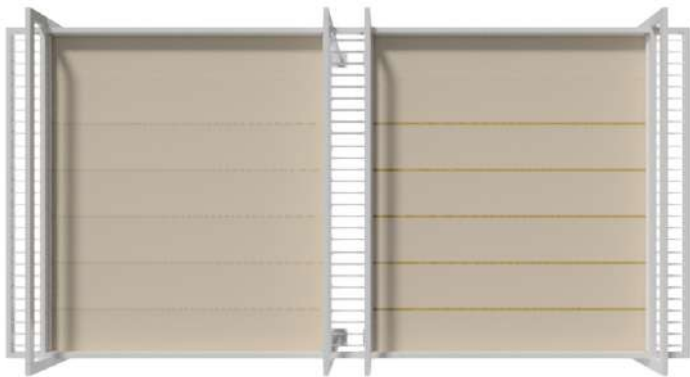

TOP VIEW



FRONT VIEW



SIDE VIEW

IN DEMAND TRADING (PTY) LTD
 STEPPING STONES GARDEN VILLAGE
 283 OLD HONEYDEW ROAD WEST
 NORTHRIDING, JHB, GAUTENG, RSA

T// +27 (0)21 791 1888
 SALES@INDEMANDTRADING.CO.ZA
 WWW.INDEMANDTRADING.CO.ZA



INDEMANDdrawingoffice.co.za
 Download BIM, DWG and 3D model tensile shade structures

DESCRIPTION

TANDEM MANUAL RETRACTABLE PERGOLA

CATEGORY
 STANDARD STRUCTURE

CATEGORY
 STANDARD STRUCTURE

PERGOLA OPTIONS:

ARCHITECTURAL PVC, PROOF AND SHADECLOTH

IMAGE FORMAT

.PNG

SOFTWARE

AUTODESK INVENTOR

YEAR DRAWN

2018

MODEL FORMAT

.BIM / .SAT

YEAR FIRST MANUFACTURED

2018

SCALE

NOT TO SCALE

COPY RIGHT YEAR

2019

SIZES

VARIOUS

INDEMANDDRAWINGOFFICE.CO.ZA LINK

CLICK HERE

DRAWING CATEGORY

RENDER STD-TP001



FIRST ANGLE PROJECTION



THE CONTENTS OF THIS DRAWING IS THE SOLE PROPERTY OF IN DEMAND TRADING (PTY) LTD AND MAY NOT BE COPIED OR DIVULGED TO ANY THIRD PARTY WITHOUT THE WRITTEN CONSENT
 In Demand Trading (Pty) Ltd | Reg Number: 2014/057552/07 | VAT Number: 4568746



PERSEPTIVE VIEW



TOP VIEW



FRONT VIEW



SIDE VIEW

IN DEMAND TRADING (PTY) LTD
 STEPPING STONES GARDEN VILLAGE
 283 OLD HONEYDEW ROAD WEST
 NORTHRIDING, JHB, GAUTENG, RSA

T// +27 (0)21 791 1888
 SALES@INDEMANDTRADING.CO.ZA
 WWW.INDEMANDTRADING.CO.ZA



INDEMANDdrawingoffice.co.za
 Download BIM, DWG and 3D model tensile shade structures

DESCRIPTION

STEEL PERGOLA

CATEGORY

STANDARD STRUCTURE - WOOD

CATEGORY

STANDARD STRUCTURE

IMAGE FORMAT

.PNG

SOFTWARE

AUTODESK INVENTOR

YEAR DRAWN

2018

YEAR FIRST MANUFACTURED

2018

COPY RIGHT YEAR

2018

MEMBRANE OPTIONS:

ARCHITECTURAL PVC, PROOF AND SHADECLOTH

MODEL FORMAT

.BIM / .SAT

SCALE

NOT TO SCALE

SIZES

VARIOUS

INDEMANDDRAWINGOFFICE.CO.ZA LINK

CLICK HERE

DRAWING CATEGORY

RENDER STD-ST001



FIRST ANGLE PROJECTION



THE CONTENTS OF THIS DRAWING IS THE SOLE PROPERTY OF IN DEMAND TRADING (PTY) LTD
 AND MAY NOT BE COPIED, DIVULGED TO ANY THIRD PARTY WITHOUT THE WRITTEN CONSENT
 In Demand Trading (Pty) Ltd | Reg Number: 2014/057552/07 | VAT Number: 4568746



PERSPECTIVE



TOP VIEW

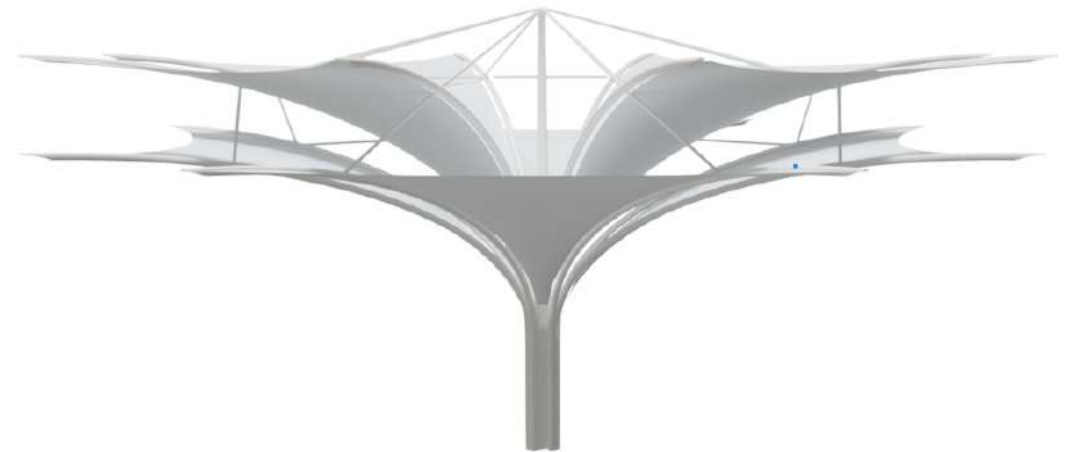

SIDE VIEW

IN DEMAND TRADING (PTY) LTD
 STEPPING STONES GARDEN VILLAGE
 283 OLD HONEYDEW ROAD WEST
 NORTHRIDING, JHB, GAUTENG, RSA



INDEMANDdrawingoffice.co.za
 Download BIM, DWG and 3D model tensile shade structures

DESCRIPTION

TENSILE TREE

CATEGORY
 STANDARD STRUCTURE

CATEGORY
 STANDARD STRUCTURE

MEMBRANE OPTIONS
 ARCHITECTURAL PVC

IMAGE FORMAT
 .PNG

SOFTWARE
 AUTODESK INVENTOR

YEAR DRAWN
 2014

MODEL FORMAT
 .BIM / .SAT

YEAR FIRST MANUFACTURED
 2014

SCALE
 NOT TO SCALE

COPY RIGHT YEAR
 2019

SIZES
 OD 25m

INDEMANDDRAWINGOFFICE.CO.ZA LINK



DRAWING CATEGORY
 RENDER STD-BS001



FIRST ANGLE PROJECTION



THE CONTENTS OF THIS DRAWING IS THE SOLE PROPERTY OF IN DEMAND TRADING (PTY) LTD
 AND MAY NOT BE COPIED, OF DIVULGED TO ANY THIRD PARTY WITHOUT THE WRITTEN CONSENT
 In Demand Trading (Pty) Ltd | Reg Number: 2014/057552/07 | VAT Number: 4568746



PERSPECTIVE VIEW



TOP VIEW



FRONT VIEW

IN DEMAND TRADING (PTY) LTD
 STEPPING STONES GARDEN VILLAGE
 283 OLD HONEYDEW ROAD WEST
 NORTHRIDING, JHB, GAUTENG, RSA

T// +27 (0)21 791 1888
 SALES@INDEMANDTRADING.CO.ZA
 WWW.INDEMANDTRADING.CO.ZA



INDEMANDdrawingoffice.co.za
 Download BIM, DWG and 3D model tensile shade structures

DESCRIPTION

PLAYPORT 8 000 X 8 000MM

CATEGORY
 STANDARD STRUCTURE

CATEGORY
 STANDARD STRUCTURE

MEMBRANE OPTIONS
 SHADECLOTH

IMAGE FORMAT
 .PNG

SOFTWARE
 AUTODESK INVENTOR

YEAR DRAWN
 2009

MODEL FORMAT
 .BIM / .SATT

YEAR FIRST MANUFACTURED
 2009

SCALE
 NOT TO SCALE

COPY RIGHT YEAR
 2019

SIZES
 10 X 10M

INDEMANDDRAWINGOFFICE.CO.ZA LINK



DRAWING CATEGORY
 RENDER STD-PP001



FIRST ANGLE PROJECTION



THE CONTENTS OF THIS DRAWING IS THE SOLE PROPERTY OF IN DEMAND TRADING (PTY) LTD
 AND MAY NOT BE COPIED OR DIVULGED TO ANY THIRD PARTY WITHOUT THE WRITTEN CONSENT
 In Demand Trading (Pty) Ltd | Reg Number: 2014/057552/07 | VAT Number: 4568746



FRONT VIEW



TOP VIEW

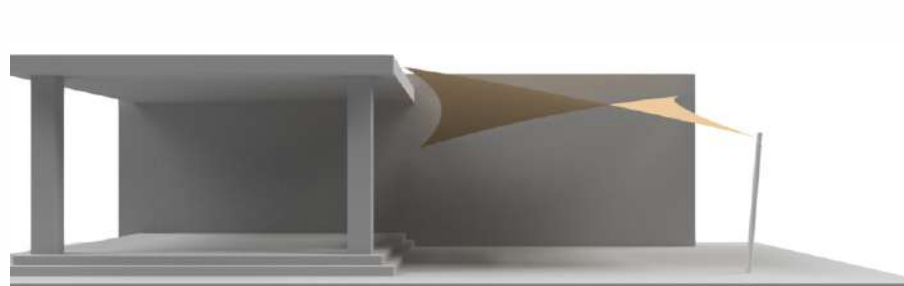

FRONT VIEW



SIDE VIEW

IN DEMAND TRADING (PTY) LTD
 STEPPING STONES GARDEN VILLAGE
 283 OLD HONEYDEW ROAD WEST
 NORTHRIDING, JHB, GAUTENG, RSA

T// +27 (0)21 791 1888
 SALES@INDEMANDTRADING.CO.ZA
 WWW.INDEMANDTRADING.CO.ZA



INDEMANDdrawingoffice.co.za
 Download BIM, DWG and 3D model tensile shade structures

DESCRIPTION

TENSILE SAIL

CATEGORY
 SAIL STRUCTURE

IMAGE FORMAT
 CUSTOM STRUCTURE .PNG

SOFTWARE
 ARCHITECTURAL PVC AND THERMOFLEX

INDEMANDDRAWINGOFFICE.CO.ZA LINK

CLICK HERE

DRAWING CATEGORY

RENDER CUS-TS004

YEAR DRAWN
 2010

MODEL FORMAT
 .BIM / .SATT

YEAR FIRST MANUFACTURED
 2010

SCALE
 NOT TO SCALE



FIRST ANGLE PROJECTION

COPY RIGHT YEAR
 2019

SIZES
 VARIOUS



THE CONTENTS OF THIS DRAWING IS THE SOLE PROPERTY OF IN DEMAND TRADING (PTY) LTD
 AND MAY NOT BE COPIED OF DIVULGED TO ANY THIRD PARTY WITHOUT THE WRITTEN CONSENT
 In Demand Trading (Pty) Ltd | Reg Number: 2014/057552/07 | VAT Number: 4568746

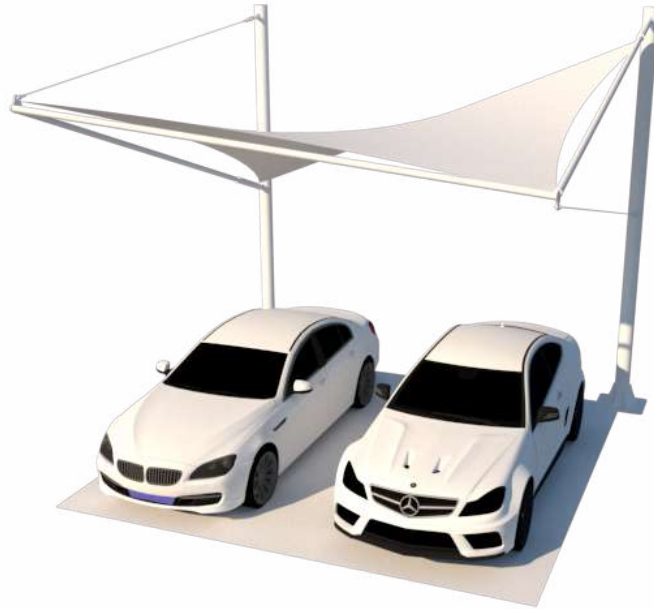

PERS VIEW



FRONT VIEW

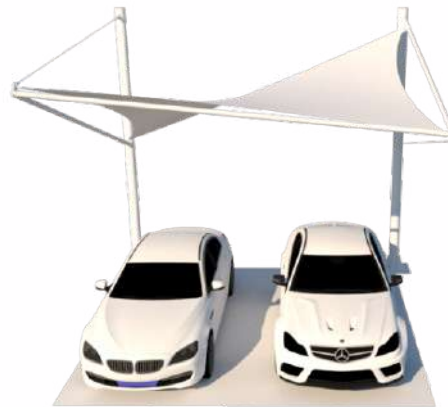

SIDE VIEW

IN DEMAND TRADING (PTY) LTD
 STEPPING STONES GARDEN VILLAGE
 283 OLD HONEYDEW ROAD WEST
 NORTHRIDING, JHB, GAUTENG, RSA



INDEMANDdrawingoffice.co.za
 Download BIM, DWG and 3D model tensile shade structures

DESCRIPTION
FULL CANTILEVER NAUTILUS SHADEPORT STAND ALONE

CATEGORY
STANDARD STRUCTURE

CATEGORY
STANDARD STRUCTURE

MEMBRANE OPTIONS
SHADECLOTH, THERMOFLEX, ARCHITECTURAL PVC

IMAGE FORMAT
.PNG

SOFTWARE
AUTODESK INVENTOR

YEAR DRAWN
2019

MODEL FORMAT
.BIM / .SATT

YEAR FIRST MANUFACTURED
2019

SCALE
NOT TO SCALE



FIRST ANGLE PROJECTION

COPY RIGHT YEAR
2019

SIZES
VARIOUS

INDEMANDDRAWINGOFFICE.CO.ZA LINK



DRAWING CATEGORY

RENDER STD-SN001



THE CONTENTS OF THIS DRAWING IS THE SOLE PROPERTY OF IN DEMAND TRADING (PTY) LTD
 AND MAY NOT BE COPIED OR DIVULGED TO ANY THIRD PARTY WITHOUT THE WRITTEN CONSENT
 In Demand Trading (Pty) Ltd | Reg Number: 2014/057552/07 | VAT Number: 4568746



PERS VIEW



FRONT VIEW



SIDE VIEW

IN DEMAND TRADING (PTY) LTD
 STEPPING STONES GARDEN VILLAGE
 283 OLD HONEYDEW ROAD WEST
 NORTHRIDING, JHB, GAUTENG, RSA

T// +27 (0)21 791 1888
 SALES@INDEMANDTRADING.CO.ZA
 WWW.INDEMANDTRADING.CO.ZA



INDEMANDdrawingoffice.co.za
 Download BIM, DWG and 3D model tensile shade structures

DESCRIPTION
 FULL CANTILEVER NAUTILUS SHADEPORT MULTI UNIT

CATEGORY
 STANDARD STRUCTURE

CATEGORY
 STANDARD STRUCTURE

MEMBRANE OPTIONS

SHADECLOTH, THERMOFLEX, ARCHITECTURAL PVC

IMAGE FORMAT
 .PNG

SOFTWARE
 AUTODESK INVENTOR

YEAR DRAWN
 2019

MODEL FORMAT
 .BIM / .SATT

YEAR FIRST MANUFACTURED
 2019

SCALE
 NOT TO SCALE



FIRST ANGLE PROJECTION

COPY RIGHT YEAR
 2019

SIZES
 VARIOUS

INDEMANDDRAWINGOFFICE.CO.ZA LINK



DRAWING CATEGORY

RENDER STD-SN002



THE CONTENTS OF THIS DRAWING IS THE SOLE PROPERTY OF IN DEMAND TRADING (PTY) LTD
 AND MAY NOT BE COPIED OR DIVULGED TO ANY THIRD PARTY WITHOUT THE WRITTEN CONSENT
 In Demand Trading (Pty) Ltd | Reg Number: 2014/057552/07 | VAT Number: 4568746



PERS VIEW



TOP VIEW

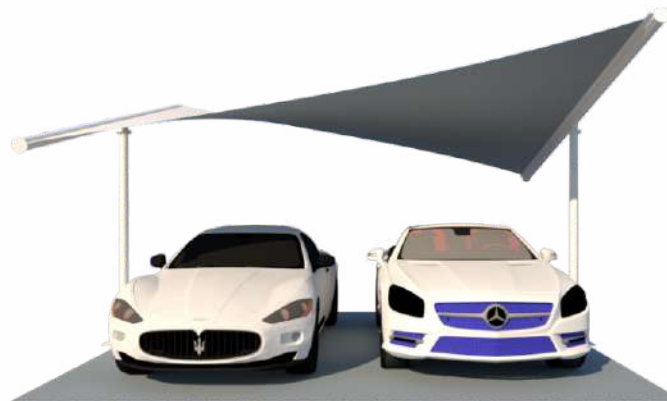

FRONT VIEW

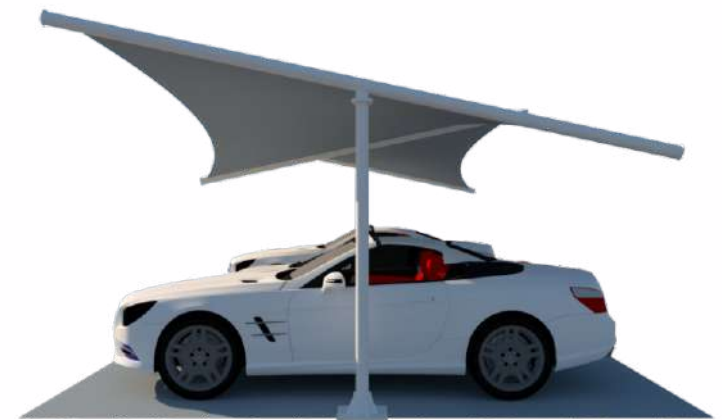

SIDE VIEW

IN DEMAND TRADING (PTY) LTD
 STEPPING STONES GARDEN VILLAGE
 283 OLD HONEYDEW ROAD WEST
 NORTHRIDING, JHB, GAUTENG, RSA

T// +27 (0)21 791 1888
 SALES@INDEMANDTRADING.CO.ZA
 WWW.INDEMANDTRADING.CO.ZA



INDEMANDdrawingoffice.co.za
 Download BIM, DWG and 3D model tensile shade structures

DESCRIPTION

SEMI CANTILEVER HYPOLEPORT SHADEPORT STAND ALONE

CATEGORY
 STANDARD STRUCTURE

CATEGORY
 STANDARD STRUCTURE

MEMBRANE OPTIONS
 SHADECLOTH, ARCHITECTURAL PVC

IMAGE FORMAT

.PNG

SOFTWARE

AUTODESK INVENTOR

YEAR DRAWN

2020

YEAR FIRST MANUFACTURED

2020

MODEL FORMAT

.BIM / .SAT

SCALE

NOT TO SCALE

COPY RIGHT YEAR

2019

SIZES

VARIOUS

INDEMANDDRAWINGOFFICE.CO.ZA LINK

CLICK HERE

DRAWING CATEGORY

RENDER STD-HP001



FIRST ANGLE PROJECTION



THE CONTENTS OF THIS DRAWING IS THE SOLE PROPERTY OF IN DEMAND TRADING (PTY) LTD
 AND MAY NOT BE COPIED OR DIVULGED TO ANY THIRD PARTY WITHOUT THE WRITTEN CONSENT
 In Demand Trading (Pty) Ltd | Reg Number: 2014/057552/07 | VAT Number: 4568746



PERS VIEW

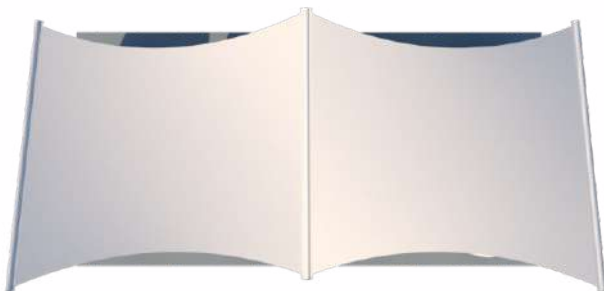

TOP VIEW



FRONT VIEW



SIDE VIEW

IN DEMAND TRADING (PTY) LTD
 STEPPING STONES GARDEN VILLAGE
 283 OLD HONEYDEW ROAD WEST
 NORTHRIDING, JHB, GAUTENG, RSA



INDEMANDdrawingoffice.co.za
 Download BIM, DWG and 3D model tensile shade structures

DESCRIPTION

SEMI CANTILEVER HYPOLEPORT SHADEPORT MULTI UNIT

CATEGORY
 STANDARD STRUCTURE

CATEGORY
 STANDARD STRUCTURE

MEMBRANE OPTIONS
 SHADECLOTH, ARCHITECTURAL PVC

IMAGE FORMAT
 .PNG

SOFTWARE
 AUTODESK INVENTOR

YEAR DRAWN
 2020

MODEL FORMAT
 .BIM / .SATT

YEAR FIRST MANUFACTURED
 2020

SCALE
 NOT TO SCALE



FIRST ANGLE PROJECTION

COPY RIGHT YEAR
 2019

SIZES
 VARIOUS

INDEMANDDRAWINGOFFICE.CO.ZA LINK



DRAWING CATEGORY
 RENDER STD-HP002



THE CONTENTS OF THIS DRAWING IS THE SOLE PROPERTY OF IN DEMAND TRADING (PTY) LTD
 AND MAY NOT BE COPIED OR DIVULGED TO ANY THIRD PARTY WITHOUT THE WRITTEN CONSENT
 In Demand Trading (Pty) Ltd | Reg Number: 2014/057552/07 | VAT Number: 4568746



PERS VIEW



TOP VIEW

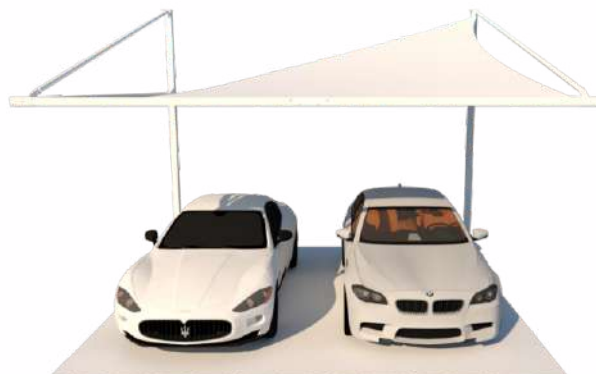

FRONT VIEW



SIDE VIEW

IN DEMAND TRADING (PTY) LTD
 STEPPING STONES GARDEN VILLAGE
 283 OLD HONEYDEW ROAD WEST
 NORTHRIDING, JHB, GAUTENG, RSA

T// +27 (0)21 791 1888
 SALES@INDEMANDTRADING.CO.ZA
 WWW.INDEMANDTRADING.CO.ZA



INDEMANDdrawingoffice.co.za
 Download BIM, DWG and 3D model tensile shade structures

DESCRIPTION
 FULL CANTILEVER SHADESAIL SHADEPORT STAND ALONE

CATEGORY
 STANDARD STRUCTURE

CATEGORY
 STANDARD STRUCTURE

MEMBRANE OPTIONS
 SHADECLOTH

IMAGE FORMAT
 .PNG

SOFTWARE
 AUTODESK INVENTOR

YEAR DRAWN
 2019

MODEL FORMAT
 .BIM / .SAT

YEAR FIRST MANUFACTURED
 2019

SCALE
 NOT TO SCALE



FIRST ANGLE PROJECTION

COPY RIGHT YEAR
 2019

SIZES
 VARIOUS

INDEMANDDRAWINGOFFICE.CO.ZA LINK



DRAWING CATEGORY

RENDER STD-SP003



THE CONTENTS OF THIS DRAWING IS THE SOLE PROPERTY OF IN DEMAND TRADING (PTY) LTD
 AND MAY NOT BE COPIED OR DIVULGED TO ANY THIRD PARTY WITHOUT THE WRITTEN CONSENT
 In Demand Trading (Pty) Ltd | Reg Number: 2014/057552/07 | VAT Number: 4568746

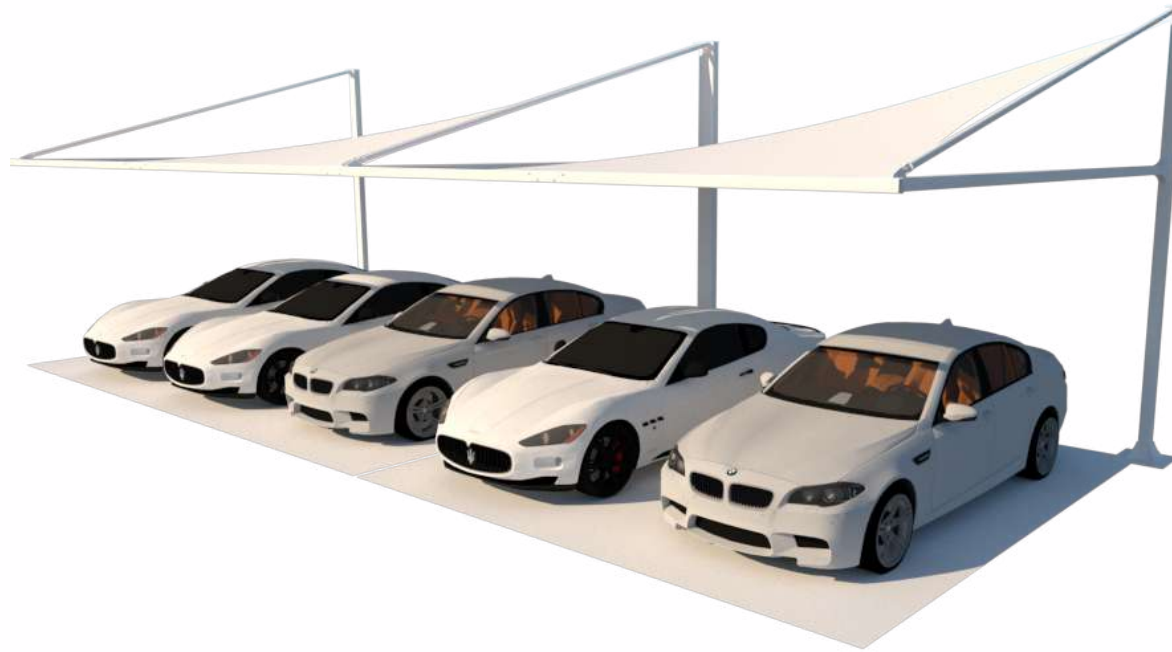

PERS VIEW

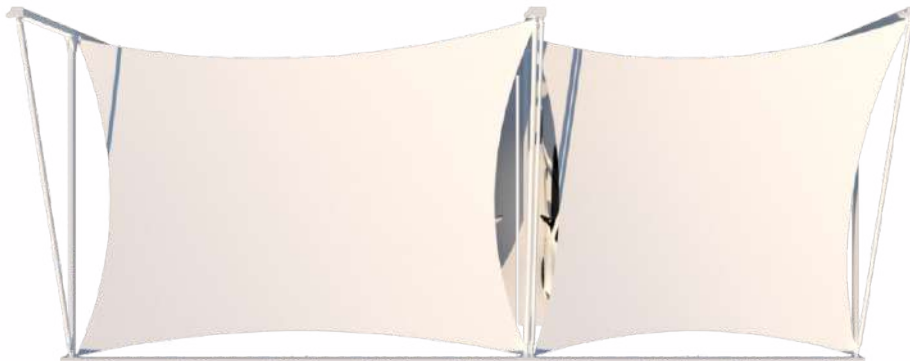

TOP VIEW

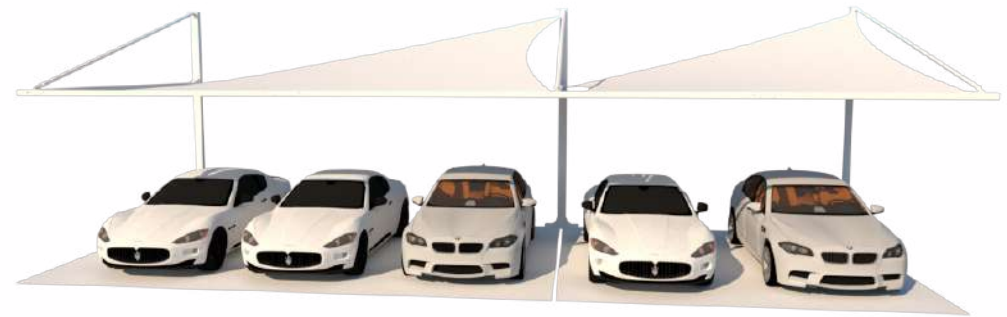

FRONT VIEW

IN DEMAND TRADING (PTY) LTD
 STEPPING STONES GARDEN VILLAGE
 283 OLD HONEYDEW ROAD WEST
 NORTHRIDING, JHB, GAUTENG, RSA



INDEMANDdrawingoffice.co.za
 Download BIM, DWG and 3D model tensile shade structures

DESCRIPTION
FULL CANTILEVER SHADESAIL SHADEPORT MULTIUNIT

CATEGORY
STANDARD STRUCTURE

CATEGORY
STANDARD STRUCTURE

MEMBRANE OPTIONS
SHADECLOTH

IMAGE FORMAT
.PNG

SOFTWARE
AUTODESK INVENTOR

YEAR DRAWN
2019

MODEL FORMAT
.BIM / .SATT

YEAR FIRST MANUFACTURED
2019

SCALE
NOT TO SCALE



FIRST ANGLE PROJECTION

COPY RIGHT YEAR
2019

SIZES
VARIOUS

INDEMANDDRAWINGOFFICE.CO.ZA LINK



DRAWING CATEGORY

RENDER STD-SP004



THE CONTENTS OF THIS DRAWING IS THE SOLE PROPERTY OF IN DEMAND TRADING (PTY) LTD AND MAY NOT BE COPIED OR DIVULGED TO ANY THIRD PARTY WITHOUT THE WRITTEN CONSENT
 In Demand Trading (Pty) Ltd | Reg Number: 2014/057552/07 | VAT Number: 4568746

T// +27 (0)21 791 1888
 SALES@INDEMANDTRADING.CO.ZA
 WWW.INDEMANDTRADING.CO.ZA



PERS VIEW



TOP VIEW



FRONT VIEW



IN DEMAND TRADING (PTY) LTD
 STEPPING STONES GARDEN VILLAGE
 283 OLD HONEYDEW ROAD WEST
 NORTHRIDING, JHB, GAUTENG, RSA



INDEMANDdrawingoffice.co.za
 Download BIM, DWG and 3D model tensile shade structures

DESCRIPTION

FULL CANTILEVER PYRAMID SHADEPORT STANDALONE

CATEGORY
 STANDARD STRUCTURE

CATEGORY
 STANDARD STRUCTURE

MEMBRANE OPTIONS
 SHADECLOTH

IMAGE FORMAT
 .PNG

SOFTWARE
 AUTODESK INVENTOR

YEAR DRAWN
 2019

MODEL FORMAT
 .BIM / .SATT

YEAR FIRST MANUFACTURED
 2019

SCALE
 NOT TO SCALE



FIRST ANGLE PROJECTION

COPY RIGHT YEAR
 2019

SIZES
 VARIOUS



THE CONTENTS OF THIS DRAWING IS THE SOLE PROPERTY OF IN DEMAND TRADING (PTY) LTD
 AND MAY NOT BE COPIED OR DIVULGED TO ANY THIRD PARTY WITHOUT THE WRITTEN CONSENT
 In Demand Trading (Pty) Ltd | Reg Number: 2014/057552/07 | VAT Number: 4568746



PERS VIEW

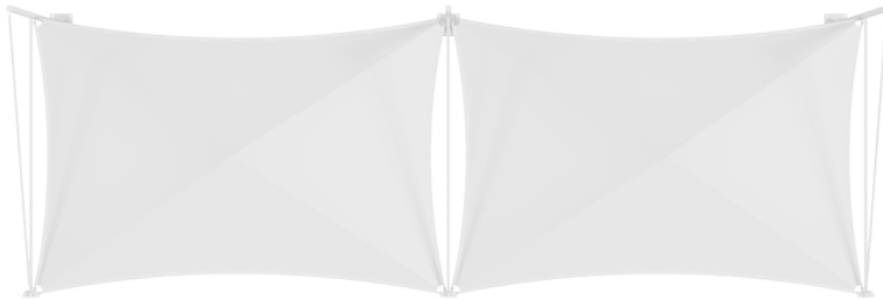

TOP VIEW



FRONT VIEW

IN DEMAND TRADING (PTY) LTD
 STEPPING STONES GARDEN VILLAGE
 283 OLD HONEYDEW ROAD WEST
 NORTHRIDING, JHB, GAUTENG, RSA



INDEMANDdrawingoffice.co.za
 Download BIM, DWG and 3D model tensile shade structures

DESCRIPTION

FULL CANTILEVER PYRAMID SHADEPORT MULTIUNIT

CATEGORY
 STANDARD STRUCTURE

CATEGORY
 STANDARD STRUCTURE

MEMBRANE OPTIONS
 SHADECLOTH

IMAGE FORMAT
 .PNG

SOFTWARE
 AUTODESK INVENTOR

YEAR DRAWN
 2019

MODEL FORMAT
 .BIM / .SAT

YEAR FIRST MANUFACTURED
 2019

SCALE
 NOT TO SCALE



FIRST ANGLE PROJECTION

COPY RIGHT YEAR
 2019

SIZES
 VARIOUS

INDEMANDDRAWINGOFFICE.CO.ZA LINK



DRAWING CATEGORY

RENDER STD-SP006



THE CONTENTS OF THIS DRAWING IS THE SOLE PROPERTY OF IN DEMAND TRADING (PTY) LTD
 AND MAY NOT BE COPIED, DIVULGED TO ANY THIRD PARTY WITHOUT THE WRITTEN CONSENT
 In Demand Trading (Pty) Ltd | Reg Number: 2014/057552/07 | VAT Number: 4568746

T// +27 (0)21 791 1888
 SALES@INDEMANDTRADING.CO.ZA
 WWW.INDEMANDTRADING.CO.ZA

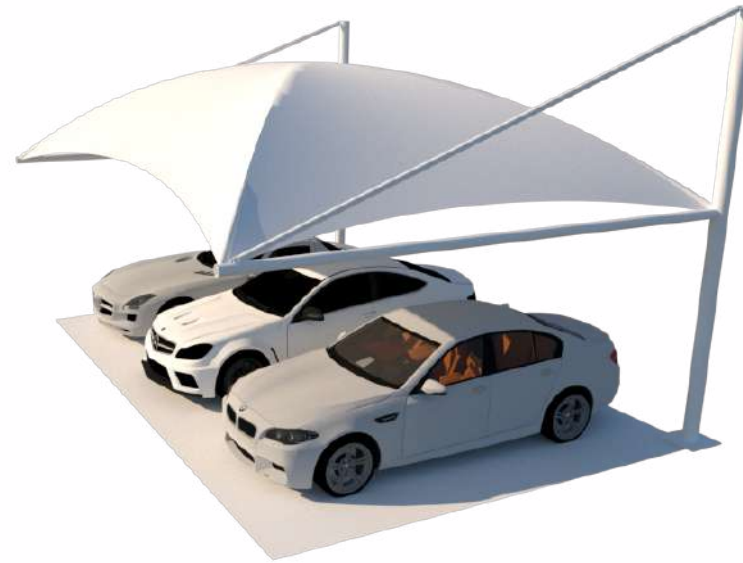

PERS VIEW



TOP VIEW

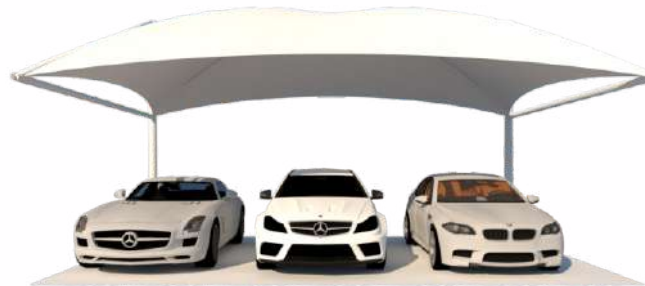

FRONT VIEW



SIDE VIEW

IN DEMAND TRADING (PTY) LTD
 STEPPING STONES GARDEN VILLAGE
 283 OLD HONEYDEW ROAD WEST
 NORTHRIDING, JHB, GAUTENG, RSA



INDEMANDdrawingoffice.co.za
 Download BIM, DWG and 3D model tensile shade structures

DESCRIPTION
FULL CANTILEVER GAZEBO SHADEPORT STANDALONE

CATEGORY
STANDARD STRUCTURE

CATEGORY
STANDARD STRUCTURE

PERFORMANCE OPTIONS
SHADECLOTH

IMAGE FORMAT
.PNG

SOFTWARE
AUTODESK INVENTOR

YEAR DRAWN
2019

MODEL FORMAT
.BIM / .SAT

YEAR FIRST MANUFACTURED
2019

SCALE
NOT TO SCALE



FIRST ANGLE PROJECTION

COPY RIGHT YEAR
2019

SIZES
VARIOUS

INDEMANDDRAWINGOFFICE.CO.ZA LINK



DRAWING CATEGORY

RENDER STD-SP003



THE CONTENTS OF THIS DRAWING IS THE SOLE PROPERTY OF IN DEMAND TRADING (PTY) LTD
 AND MAY NOT BE COPIED OR DIVULGED TO ANY THIRD PARTY WITHOUT THE WRITTEN CONSENT
 In Demand Trading (Pty) Ltd | Reg Number: 2014/057552/07 | VAT Number: 4568746



PERS VIEW



TOP VIEW



FRONT VIEW

IN DEMAND TRADING (PTY) LTD
 STEPPING STONES GARDEN VILLAGE
 283 OLD HONEYDEW ROAD WEST
 NORTHRIDING, JHB, GAUTENG, RSA



INDEMANDdrawingoffice.co.za
 Download BIM, DWG and 3D model tensile shade structures

DESCRIPTION

FULL CANTILEVER GAZEBO SHADEPORT **STANDARD**

CATEGORY
 STANDARD STRUCTURE

CATEGORY
 STANDARD STRUCTURE

MEMBRANE OPTIONS
 SHADECLOTH

IMAGE FORMAT
 .PNG

SOFTWARE
 AUTODESK INVENTOR

YEAR DRAWN
 2019

MODEL FORMAT
 .BIM / .SATT

YEAR FIRST MANUFACTURED
 2019

SCALE
 NOT TO SCALE



FIRST ANGLE PROJECTION
 COPY RIGHT YEAR
 2019

SIZES
 VARIOUS

INDEMANDDRAWINGOFFICE.CO.ZA LINK



DRAWING CATEGORY
 RENDER STD-SPOOB



THE CONTENTS OF THIS DRAWING IS THE SOLE PROPERTY OF IN DEMAND TRADING (PTY) LTD
 AND MAY NOT BE COPIED OR DIVULGED TO ANY THIRD PARTY WITHOUT THE WRITTEN CONSENT
 In Demand Trading (Pty) Ltd | Reg Number: 2014/057552/07 | VAT Number: 4568746



FRONT VIEW

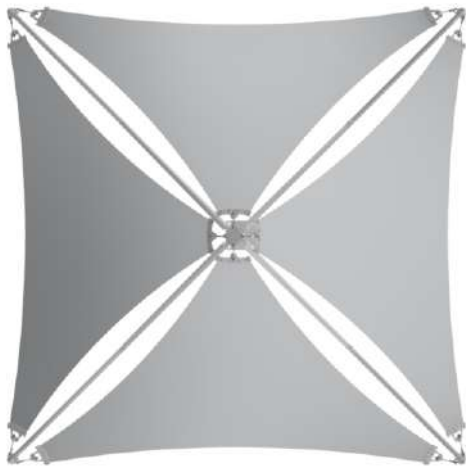

TOP VIEW



OBLIQUE VIEW



PERS VIEW

IN DEMAND TRADING (PTY) LTD
 STEPPING STONES GARDEN VILLAGE
 283 OLD HONEYDEW ROAD WEST
 NORTHRIDING, JHB, GAUTENG, RSA



INDEMANDdrawingoffice.co.za
 Download BIM, DWG and 3D model tensile shade structures

DESCRIPTION

CENTRE POST QUAD SAIL STANDALONE

CATEGORY
 STANDARD STRUCTURE

CATEGORY
 STANDARD STRUCTURE

MEMBRANE OPTIONS
 SHADECLOTH OR ARCHITECTURAL PVC

IMAGE FORMAT

.PNG

SOFTWARE

AUTODESK INVENTOR

YEAR DRAWN

2021

YEAR FIRST MANUFACTURED

2021

MODEL FORMAT

.BIM / .SAT

SCALE

NOT TO SCALE

COPY RIGHT YEAR

2019

SIZES

VARIOUS

INDEMANDDRAWINGOFFICE.CO.ZA LINK

CLICK HERE

DRAWING CATEGORY

RENDER STD QS001



FIRST ANGLE PROJECTION



THE CONTENTS OF THIS DRAWING IS THE SOLE PROPERTY OF IN DEMAND TRADING (PTY) LTD AND MAY NOT BE COPIED OR DIVULGED TO ANY THIRD PARTY WITHOUT THE WRITTEN CONSENT
 In Demand Trading (Pty) Ltd | Reg Number: 2014/057552/07 | VAT Number: 4568746



PERS VIEW



TOP VIEW



SIDE VIEW



FRONT VIEW

IN DEMAND TRADING (PTY) LTD
 STEPPING STONES GARDEN VILLAGE
 283 OLD HONEYDEW ROAD WEST
 NORTHRIDING, JHB, GAUTENG, RSA



INDEMANDdrawingoffice.co.za
 Download BIM, DWG and 3D model tensile shade structures

DESCRIPTION
 SEMICANTILEVER QUAD SAIL STANDALONE

CATEGORY
 STANDARD STRUCTURE

CATEGORY
 STANDARD STRUCTURE

MEMBRANE OPTIONS
 SHADECLOTH OR ARCHITECTURAL PVC

IMAGE FORMAT
 .PNG

SOFTWARE
 AUTODESK INVENTOR

INDEMANDDRAWINGOFFICE.CO.ZA LINK



DRAWING CATEGORY
 RENDER STD QSC001

YEAR DRAWN
 2021

MODEL FORMAT
 .BIM / .SAT

YEAR FIRST MANUFACTURED
 2021

SCALE
 NOT TO SCALE



FIRST ANGLE PROJECTION

COPY RIGHT YEAR
 2019

SIZES
 VARIOUS



THE CONTENTS OF THIS DRAWING IS THE SOLE PROPERTY OF IN DEMAND TRADING (PTY) LTD
 AND MAY NOT BE COPIED, OF DIVULGED TO ANY THIRD PARTY WITHOUT THE WRITTEN CONSENT
 In Demand Trading (Pty) Ltd | Reg Number: 2014/057552/07 | VAT Number: 4568746

T// +27 (0)21 791 1888
 SALES@INDEMANDTRADING.CO.ZA
 WWW.INDEMANDTRADING.CO.ZA



PERS VIEW

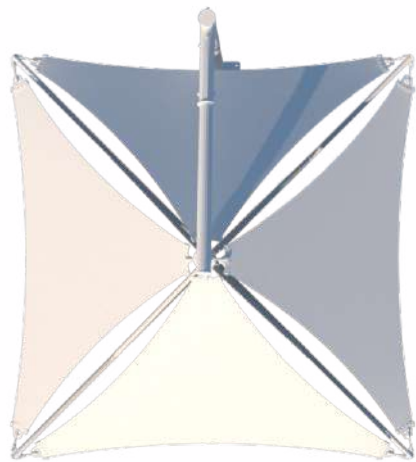

TOP VIEW



SIDE VIEW



FRONT VIEW

IN DEMAND TRADING (PTY) LTD
 STEPPING STONES GARDEN VILLAGE
 283 OLD HONEYDEW ROAD WEST
 NORTHRIDING, JHB, GAUTENG, RSA



INDEMANDdrawingoffice.co.za
 Download BIM, DWG and 3D model tensile shade structures

DESCRIPTION
FULL CANTILEVER QUAD SAIL STANDALONE

CATEGORY
STANDARD STRUCTURE

CATEGORY
STANDARD STRUCTURE

MEMBRANE OPTIONS
SHADECLOTH OR ARCHITECTURAL PVC

IMAGE FORMAT
.PNG

SOFTWARE
AUTODESK INVENTOR

YEAR DRAWN
2021

MODEL FORMAT
.BIM / .SATT

YEAR FIRST MANUFACTURED
2021

SCALE
NOT TO SCALE



FIRST ANGLE PROJECTION

COPY RIGHT YEAR
2019

SIZES
VARIOUS

INDEMANDDRAWINGOFFICE.CO.ZA LINK



CLICK HERE

DRAWING CATEGORY
RENDER STD QFC001



THE CONTENTS OF THIS DRAWING IS THE SOLE PROPERTY OF IN DEMAND TRADING (PTY) LTD AND MAY NOT BE COPIED OR DIVULGED TO ANY THIRD PARTY WITHOUT THE WRITTEN CONSENT
 In Demand Trading (Pty) Ltd | Reg Number: 2014/057552/07 | VAT Number: 4568746



PERS VIEW



TOP VIEW



FRONT VIEW

IN DEMAND TRADING (PTY) LTD
 STEPPING STONES GARDEN VILLAGE
 283 OLD HONEYDEW ROAD WEST
 NORTHRIDING, JHB, GAUTENG, RSA



INDEMANDdrawingoffice.co.za
 Download BIM, DWG and 3D model tensile shade structures

DESCRIPTION

FOUR POST QUAD SAIL STANDALONE

CATEGORY
 STANDARD STRUCTURE

CATEGORY
 STANDARD STRUCTURE

MEMBRANE OPTIONS

SHADECLOTH OR ARCHITECTURAL PVC

IMAGE FORMAT

.PNG

SOFTWARE

AUTODESK INVENTOR

YEAR DRAWN

2021

MODEL FORMAT

.BIM / .SATT

YEAR FIRST MANUFACTURED

2021

SCALE

NOT TO SCALE

COPY RIGHT YEAR

2019

SIZES

VARIOUS

INDEMANDDRAWINGOFFICE.CO.ZA LINK

CLICK HERE

DRAWING CATEGORY
 RENDER STD FPQ001



FIRST ANGLE PROJECTION



THE CONTENTS OF THIS DRAWING IS THE SOLE PROPERTY OF IN DEMAND TRADING (PTY) LTD
 AND MAY NOT BE COPIED OR DIVULGED TO ANY THIRD PARTY WITHOUT THE WRITTEN CONSENT
 In Demand Trading (Pty) Ltd | Reg Number: 2014/057552/07 | VAT Number: 4568746



PERS VIEW

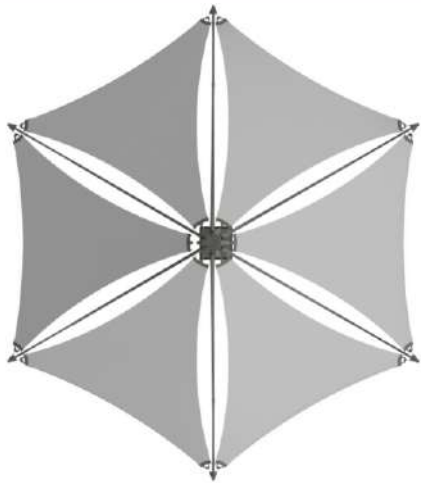

TOP VIEW



OBLIQUE VIEW



FRONT VIEW

IN DEMAND TRADING (PTY) LTD
 STEPPING STONES GARDEN VILLAGE
 283 OLD HONEYDEW ROAD WEST
 NORTHRIDING, JHB, GAUTENG, RSA

T// +27 (0)21 791 1888
 SALES@INDEMANDTRADING.CO.ZA
 WWW.INDEMANDTRADING.CO.ZA



INDEMANDdrawingoffice.co.za
 Download BIM, DWG and 3D model tensile shade structures

DESCRIPTION

CENTRE POST MULTI SAIL STANDALONE

CATEGORY
 STANDARD STRUCTURE

CATEGORY
 STANDARD STRUCTURE

MEMBRANE OPTIONS

SHADECLOTH OR ARCHITECTURAL PVC

IMAGE FORMAT
 .PNG

SOFTWARE
 AUTODESK INVENTOR

YEAR DRAWN
 2021

MODEL FORMAT
 .BIM / .SATT

YEAR FIRST MANUFACTURED
 2021

SCALE
 NOT TO SCALE



FIRST ANGLE PROJECTION

COPY RIGHT YEAR
 2019

SIZES
 VARIOUS

INDEMANDDRAWINGOFFICE.CO.ZA LINK

CLICK HERE

DRAWING CATEGORY
 RENDER STD CPM001



THE CONTENTS OF THIS DRAWING IS THE SOLE PROPERTY OF IN DEMAND TRADING (PTY) LTD AND MAY NOT BE COPIED OR DIVULGED TO ANY THIRD PARTY WITHOUT THE WRITTEN CONSENT
 In Demand Trading (Pty) Ltd | Reg Number: 2014/057552/07 | VAT Number: 4568746



OBLIQUE VIEW
PERS VIEW



TOP VIEW

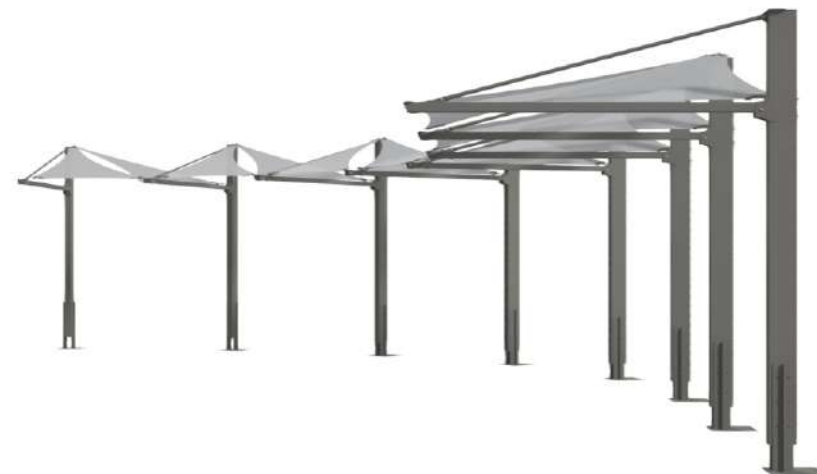

FRONT VIEW

IN DEMAND TRADING (PTY) LTD
STEPPING STONES GARDEN VILLAGE
283 OLD HONEYDEW ROAD WEST
NORTHRIDING, JHB, GAUTENG, RSA

T// +27 (0)21 791 1888
SALES@INDEMANDTRADING.CO.ZA
WWW.INDEMANDTRADING.CO.ZA



INDEMANDdrawingoffice.co.za
Download BIM, DWG and 3D model tensile shade structures

DESCRIPTION

CANTILEVER DUAL SAIL MULTIUNIT

CATEGORY

STANDARD STRUCTURE

CATEGORY

STANDARD STRUCTURE

MEMBRANE OPTIONS

SHADECLOTH OR ARCHITECTURAL PVC

IMAGE FORMAT

.PNG

SOFTWARE

AUTODESK INVENTOR

YEAR DRAWN

2021

MODEL FORMAT

.BIM / .SAT

YEAR FIRST MANUFACTURED

2021

SCALE

NOT TO SCALE

COPY RIGHT YEAR

2019

SIZES

VARIOUS

INDEMANDDRAWINGOFFICE.CO.ZA LINK

CLICK HERE

DRAWING CATEGORY

RENDER STD CDS001

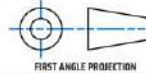

FIRST ANGLE PROJECTION



THE CONTENTS OF THIS DRAWING IS THE SOLE PROPERTY OF IN DEMAND TRADING (PTY) LTD
AND MAY NOT BE COPIED OR DIVULGED TO ANY THIRD PARTY WITHOUT THE WRITTEN CONSENT
In Demand Trading (Pty) Ltd | Reg Number: 2014/057552/07 | VAT Number: 4568746

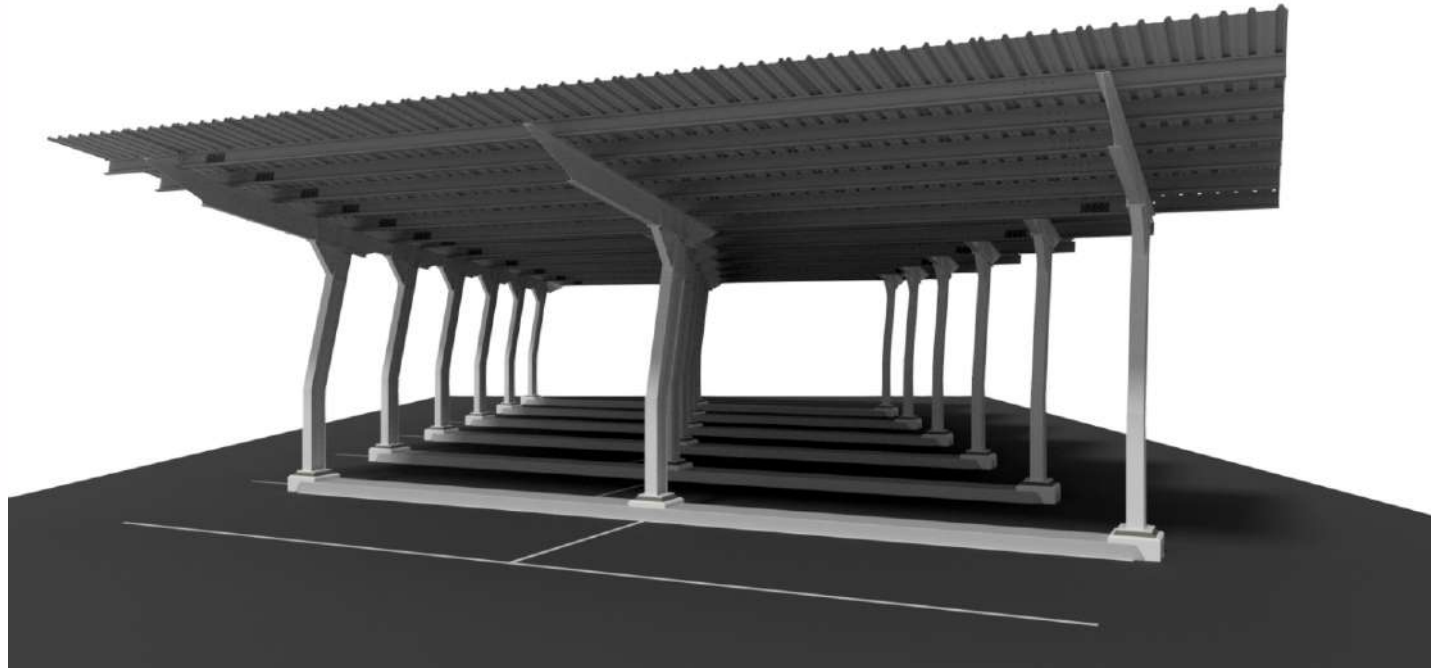

FRONT VIEW

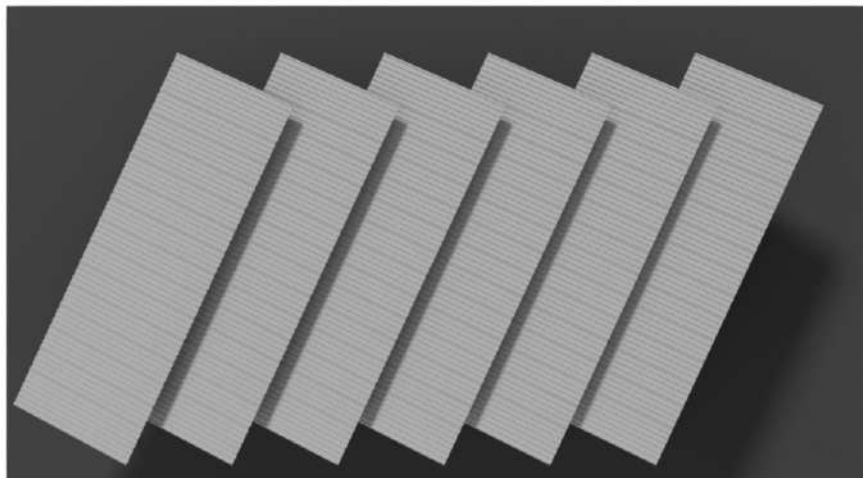

TOP VIEW

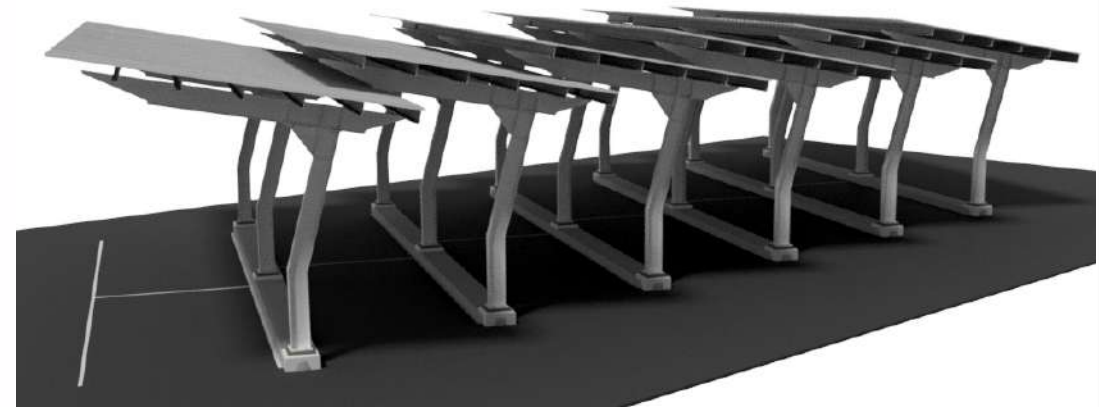

SIDE VIEW SIDE VIEW

IN DEMAND TRADING (PTY) LTD
 STEPPING STONES GARDEN VILLAGE
 283 OLD HONEYDEW ROAD WEST
 NORTHRIDING, JHB, GAUTENG, RSA

T// +27 (0)21 791 1888
 SALES@INDEMANDTRADING.CO.ZA
 WWW.INDEMANDTRADING.CO.ZA



INDEMANDdrawingoffice.co.za
 Download BIM, DWG and 3D model tensile shade structures

DESCRIPTION

SOLID ROOF CANTILEVER CARPORTS - KNEEL

CATEGORY
 STANDARD STRUCTURE

CATEGORY
 STANDARD STRUCTURE

MEMBRANE OPTIONS

CROMODECK OR OTHER SOLID ROOF SHEETING

IMAGE FORMAT

.PNG

SOFTWARE

AUTODESK INVENTOR

YEAR DRAWN

2017

MODEL FORMAT

.BIM / .SAT

YEAR FIRST MANUFACTURED

2017

SCALE

NOT TO SCALE

COPY RIGHT YEAR

2019

SIZES

VARIOUS

INDEMANDDRAWINGOFFICE.CO.ZA LINK

CLICK HERE

DRAWING CATEGORY

RENDER STD-BS001



FIRST ANGLE PROJECTION



THE CONTENTS OF THIS DRAWING IS THE SOLE PROPERTY OF IN DEMAND TRADING (PTY) LTD
 AND MAY NOT BE COPIED, REPRODUCED OR DIVULGED TO ANY THIRD PARTY WITHOUT THE WRITTEN CONSENT
 In Demand Trading (Pty) Ltd | Reg Number: 2014/057552/07 | VAT Number: 4568746

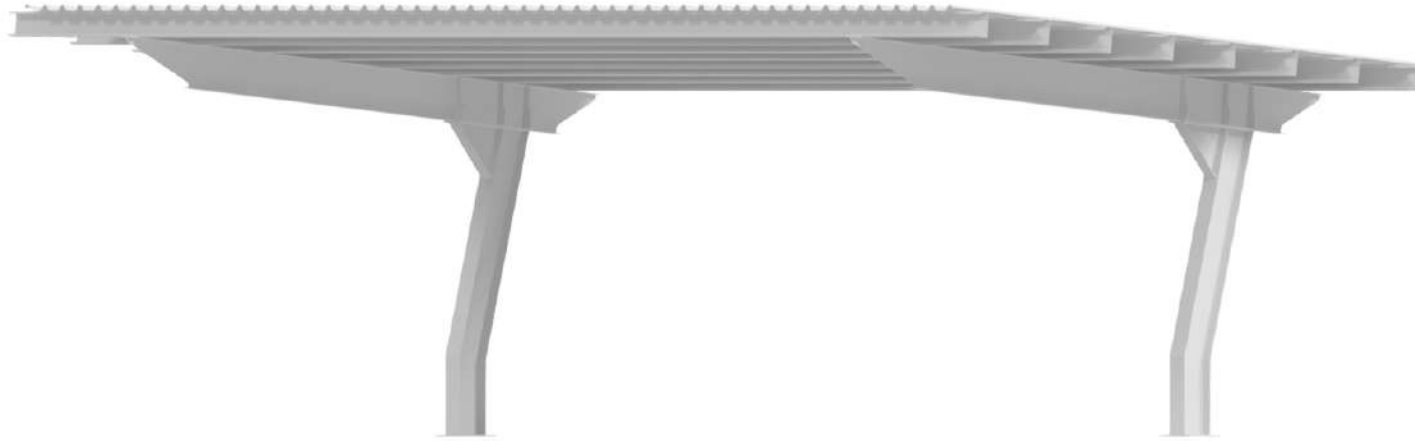

PERS VIEW

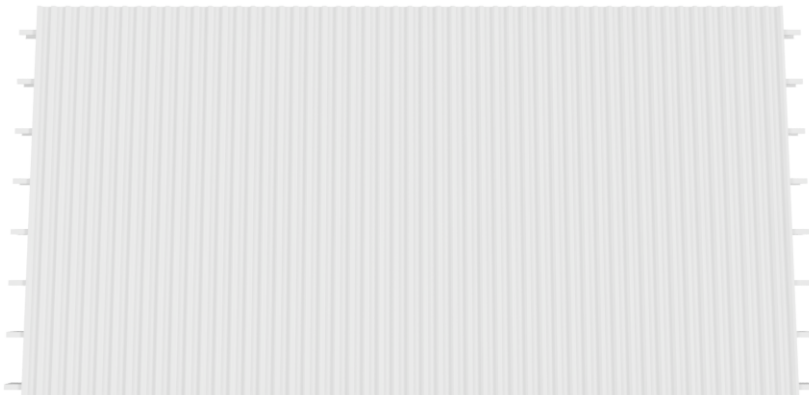

TOP VIEW



SIDE VIEW

IN DEMAND TRADING (PTY) LTD
 STEPPING STONES GARDEN VILLAGE
 283 OLD HONEYDEW ROAD WEST
 NORTHRIDING, JHB, GAUTENG, RSA

T// +27 (0)21 791 1888
 SALES@INDEMANDTRADING.CO.ZA
 WWW.INDEMANDTRADING.CO.ZA



INDEMANDdrawingoffice.co.za
 Download BIM, DWG and 3D model tensile shade structures

DESCRIPTION

SOLID ROOF CANTILEVER WALKWAY

CATEGORY
 STANDARD STRUCTURE

CATEGORY
 STANDARD STRUCTURE

MEMBRANE OPTIONS

CROMODECK OR OTHER SOLID ROOF SHEETING

IMAGE FORMAT
 .PNG

SOFTWARE
 AUTODESK INVENTOR

YEAR DRAWN
 2017

MODEL FORMAT
 .BIM / .SAT

YEAR FIRST MANUFACTURED
 2017

SCALE
 NOT TO SCALE

COPY RIGHT YEAR
 2019

SIZES
 VARIOUS

INDEMANDDRAWINGOFFICE.CO.ZA LINK

CLICK HERE

DRAWING CATEGORY
 RENDER STD-SR001



FIRST ANGLE PROJECTION



THE CONTENTS OF THIS DRAWING IS THE SOLE PROPERTY OF IN DEMAND TRADING (PTY) LTD
 AND MAY NOT BE COPIED, DIVULGED TO ANY THIRD PARTY WITHOUT THE WRITTEN CONSENT
 In Demand Trading (Pty) Ltd | Reg Number: 2014/057552/07 | VAT Number: 4568746



PERSPECTIVE VIEW

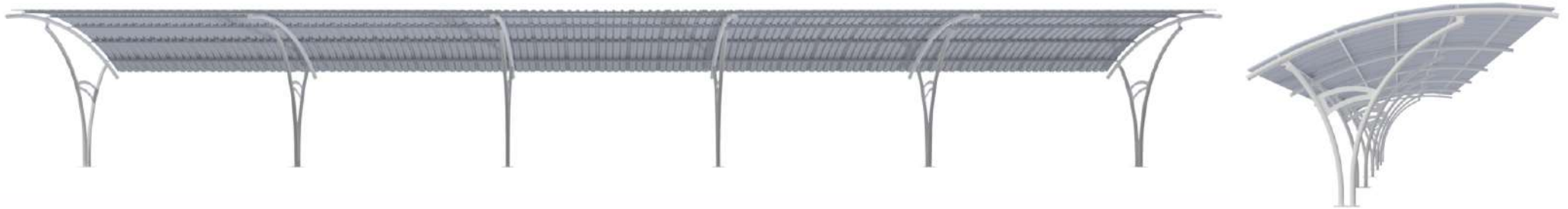

FRONT VIEW

SIDE VIEW

IN DEMAND TRADING (PTY) LTD
 STEPPING STONES GARDEN VILLAGE
 283 OLD HONEYDEW ROAD WEST
 NORTHRIDING, JHB, GAUTENG, RSA



INDEMANDdrawingoffice.co.za
 Download BIM, DWG and 3D model tensile shade structures

T// +27 (0)21 791 1888
 SALES@INDEMANDTRADING.CO.ZA
 WWW.INDEMANDTRADING.CO.ZA

DESCRIPTION

SOLID ROOF ROLLED ARCH CARPORTS

CATEGORY
 STANDARD STRUCTURE

CATEGORY
 STANDARD STRUCTURE

IMAGE FORMAT
 .PNG

SOFTWARE
 AUTODESK INVENTOR

MEMBRANE OPTIONS
 CROMODECK OR OTHER SOLID ROOF SHEETING

INDEMANDDRAWINGOFFICE.CO.ZA LINK



DRAWING CATEGORY
 RENDER STD-BS002

YEAR DRAWN
 2019

MODEL FORMAT
 .BIM / .SATT

YEAR FIRST MANUFACTURED
 2019

SCALE
 NOT TO SCALE



FIRST ANGLE PROJECTION

COPY RIGHT YEAR
 2019

SIZES
 VARIOUS



THE CONTENTS OF THIS DRAWING IS THE SOLE PROPERTY OF IN DEMAND TRADING (PTY) LTD AND MAY NOT BE COPIED OR DIVULGED TO ANY THIRD PARTY WITHOUT THE WRITTEN CONSENT
 In Demand Trading (Pty) Ltd | Reg Number: 2014/057552/07 | VAT Number: 4568746